



GUARDIAN™

- High Speed Serial Connectivity for Remote Monitoring and Control

USER MANUAL



NEXTGENRF.COM

REVISION HISTORY

REV	DATE	REVISION DETAILS
0	July 2011	Initial release as 001-5006-000.
1	August 2011	Added User Configuration section 5.1.3 Modem Mode. Added Link Configuration section 5.1.4 Modem Mode. Added User Configuration section 5.1.5 Loader Mode. Added Link Configuration section 5.1.6 Loader Mode.
2	October 2012	Added UL Information.
3	April 2013	Updated to be current with version 4.0 Field Programming Software and version 1.3 firmware. Added Section 2.5 for lightning arrestor information and added appendices for DL-3400 interoperability, DL-3282 modem interface, and T-96SR interoperability.
A	October 2014	Updated UL C1D2 Information.
B	May 2021	NextGen acquisition, Rebranding, removed obsolete models

Important Notice

Because of the nature of wireless communication, transmission and reception of data can never be guaranteed. Data may be delayed, corrupted (i.e., have errors), or be totally lost. Significant delays or losses of data are rare when wireless devices such as NextGen RF provides are used in a normal manner with a well-constructed network. These products should not be used in situations where failure to transmit or receive data could result in damage of any kind to the user or any other party, including but not limited to personal injury or death, or loss of property. NextGen RF accepts no responsibility for damages of any kind resulting from delays or errors in data transmitted or received using the Guardian serial radio, or for failure to transmit or receive such data.

Copyright Notice

© Copyright 2010-2021 NextGen RF Design. All rights reserved.

Products offered may contain software proprietary to NextGen RF or other parties. The offer of supply of these products and services does not include or infer any transfer of ownership. No part of the documentation or information supplied may be divulged to any third party without the express written consent of NextGen RF.

NextGen RF reserves the right to update its products, software, or documentation without obligation to notify any individual or entity. Product updates may result in differences between the information provided in this manual and the product shipped. For access to the most current product documentation and application notes, visit www.NextGenRF.com.

UL Listed models only



When operating at elevated temperature extremes, the surface may exceed +70 Celsius. For user safety, the Viper should be installed in a restricted access location.



WARNING — EXPLOSION HAZARD, do not connect while circuit is live unless area is known to be non-hazardous.

For more information see [APPENDIX D — UL Installation Instructions](#)

RF Exposure Compliance Requirements



The Guardian serial radio is intended for use in the Industrial Monitoring and Control and SCADA markets. The Guardian unit must be professionally installed and must ensure a minimum separation distance listed in the table below between the antenna or radiating structure and any person. An antenna mounted on a pole or tower is the typical installation and in rare instances, a ½-wave whip antenna is used.

Minimum Safety Distance	Antenna Gain		
	5 dBi	10 dBi	15 dBi
VHF at maximum Power	123 cm	218.8 cm	389 cm
UHF at Maximum Power	105.7 cm	188 cm	334.4 cm
900 MHz at Maximum Power	63.8 cm	115 cm	201.7 cm

Note: *It is the responsibility of the user to guarantee compliance with the FCC MPE regulations when operating this device in a way other than described above.*

The Guardian serial radio uses a low power radio frequency transmitter. The concentrated energy from an antenna may pose a health hazard. People should not be in front of the antenna when the transmitter is operating.

The installer of this equipment must ensure the antenna is located or pointed such that it does not emit an RF field more than Health Canada limits for the general population. Recommended safety guidelines for the human exposure to radio frequency electromagnetic energy are contained in the Canadian Safety Code 6 (available from Health Canada), the Federal Communications Commission (FCC) Bulletin 65.

Any changes or modifications not expressly approved by the party responsible for compliance (in the country where used) could void the user's authority to operate the equipment.

Regulation Certifications

The Guardian serial radio is available in several different models, each with unique frequency bands. Each model of Guardian may have different regulatory approval, as shown in the table below.

Certifications

Model Number	Frequency Range	FCC	IC (DOC)
140-5016-500	136 – 174 MHz	2AY35-5016-500	27157-5016500
140-5016-501	136 – 174 MHz	2AY35-5016-500	27157-5016500
140-5046-300	406 - 470 MHz	2AY35-5046-300	27157-5046300
140-5046-301	406 - 470 MHz	2AY35-5046-300	27157-5046300
140-5046-500	450 - 512 MHz	2AY35-5046-300	27157-5046300
140-5046-501	450 - 512 MHz	2AY35-5046-300	27157-5046300
UL Certification	All models UL approved when powered with a listed Class 2 source. This device is suitable for use in Class I, Division 2, Groups A, B, C and D or non-hazardous locations only.		

TABLE OF CONTENTS

1	Guardian Overview	1
1.1	General Description.....	1
1.2	Operational Characteristics	1
1.3	Link Configurations.....	2
1.4	Physical Description.....	3
1.4.1	Front Panel	3
1.4.2	LED Panel	3
1.4.3	User Interface Port	4
1.4.4	Setup and COM Ports	5
1.4.5	Power Connector.....	6
1.4.6	Antenna Connector	6
1.4.7	Chassis Dimensions	7
1.5	Part Numbers and Availability	7
1.5.1	Guardian Radio.....	7
1.5.2	Accessories and Options.....	8
2	System Architecture and Network Planning.....	9
2.1	Single Coverage Area.....	9
2.2	Network Architecture	9
2.2.1	Point-To-Point	9
2.2.2	Point-To-Multipoint.....	10
2.2.3	Multiple Point-To-Point	10
2.2.4	Peer-To-Peer	10
2.2.5	Store And Forward	10
2.2.6	Network Using a Guardian for Online Diagnostics.....	11
2.3	Understanding RF Path Requirements	11
2.4	Site Selection and Site Survey	11
2.4.1	Site Selection.....	11
2.4.2	Site Survey.....	12
2.5	Selecting Antenna and Lightning Arrestor Combinations	12
2.5.1	Lightning Arrestor Overview.....	12
2.5.2	Antenna Overview.....	12
2.5.3	The Wrong Combination	12
2.5.4	Good Design Practices	14
2.6	Selecting Antenna and Feedline.....	14
2.6.1	Antenna Gain	14
2.6.2	Omni-Directional Antenna.....	15
2.6.3	Yagi Antenna	15
2.6.4	Vertical Dipoles	15
2.6.5	Feedline	15
2.6.6	RF Exposure Compliance Requirements.....	16

2.7	Terrain and Signal Strength	17
2.8	Radio Interference.....	17
3	Setup And Configuration.....	18
3.1	Install The Antenna	18
3.2	Measure And Connect Primary Power	18
3.3	Inserting Wires into User Port Connector	18
3.4	Connect Guardian to Programming PC	19
3.5	Guardian Field Programming Software	19
4	Unit Status.....	20
4.1	Unit Identification and Status	20
4.1.1	Long ID Number	20
4.1.2	Short ID	20
4.2	Diagnostics.....	20
4.2.1	Online Diagnostics.....	21
4.2.2	Offline Diagnostics.....	21
4.2.3	Remote Commands	21
5	Guardian Field Programming Software	22
5.1	Introduction	22
5.2	Guardian Programmer Window.....	22
5.3	Port Settings.....	23
5.3.1	Primary and Secondary Port Settings Communications Modes	24
5.4	Port Statistics	25
5.5	User Configuration — Modem Mode.....	26
5.6	Link Configuration — Modem Mode.....	28
5.6.1	Modem Settings	30
5.6.2	RF Link.....	31
5.6.3	COM Port	32
5.7	User Port Configuration — Modem Mode	33
5.8	User Configuration — Loader Mode	35
5.9	Link Configuration — Loader Mode	37
5.9.1	RF LINK.....	38
5.9.2	Loader Settings.....	39
5.9.3	Loader Filter Settings.....	39
5.10	User Port Configuration — Loader Mode.....	40
5.11	Version Request	41
5.12	Writing and Reading Guardian Configuration Parameters.....	41
5.13	Diagnostic IDs, Alarms and Filters	42
5.14	Offline Link Test.....	44
5.15	Offline Diagnostics.....	45

5.16	Online Diagnostics.....	47
5.17	Packet Test.....	49
5.18	Array Test.....	50
5.19	ASCII / Hex Terminal.....	52
5.19.1	ASCII Terminal.....	53
5.19.2	HEX Terminal.....	53
5.20	Guardian Firmware And Configuration	53
5.21	End to End Test	54
6	Guardian Specifications	56
	APPENDIX A — Abbreviations and Definitions	59
	APPENDIX B — Guardian and DL-3400 Interoperability	60
	Applicable Products	60
	Application.....	60
	Hardware	60
	Programming and Setup	61
	Set Guardian Parameters	63
	Link Configuration.....	65
	Programming.....	67
	Installation.....	69
	APPENDIX C — Guardian and DL-3282 Modem Interface	71
	Applicable Products	71
	Application.....	71
	Hardware.....	71
	Programming and setup.....	72
	DL-3282 Interface to Guardian	78
	Programming and Operational Hints.....	80
	APPENDIX D — Guardian and T-96SR Interoperability.....	81
	Applicable Products	81
	Application.....	81
	Hardware.....	81
	Programming and Setup	82
	Link Configuration.....	86
	Installation.....	88
	APPENDIX E — Service And Support And Warranty Statement	90
	Warranty Statement	91

1 GUARDIAN OVERVIEW

This document provides information required for the operation and verification of the NextGen RF Guardian narrowband modem.

1.1 GENERAL DESCRIPTION

This DSP-based radio is designed for SCADA, telemetry, and industrial applications in the 136-174 MHz, 215-240 MHz-VHF, 406.1-512 MHz UHF, and 928-960 MHz frequency ranges.

Guardian supports serial Remote Terminal Units (RTU) and programmable logic controllers (PLC).

1.2 OPERATIONAL CHARACTERISTICS

The Guardian Narrowband Modem has the following operational characteristics.

- Frequency range of 136-174 MHz, 215-240 MHz, 406.1-470 MHz, 450-512 MHz, or 928-960 MHz
- User-selectable data rates.
- Built-in transceiver adjustable from 1 to 10 watts (8 watts max for 900MHz).
- Wide input power range of 10 to 30 volts DC.
- Online and Offline Diagnostics.
- Supports up to 8 different link configurations which include frequency channel pairs (selectable through user interface port). See the following section, 1.3
- Industrial operating temperature range of -30° C to +60° C.
- Rugged die-cast aluminum and steel case.
- UL Certified for Hazardous Locations when powered by a listed Class 2 source.

These features provide system benefits that give users

Rugged Packaging Guardian is housed in a compact and rugged cast aluminum case. Built for industrial applications in a variety of environments, Guardian operates over an extended temperature range and provides worry-free operation in the roughest environments.

Simple Installation Basic installation typically utilizes an omnidirectional antenna at the master station or Relay Point and a directional antenna at each remote site not a Relay Point. See Sections 2.3, 2.4, and 2.5 for information about Site and Antenna Selection. For basic service, just hook up an antenna, apply primary power, then check and set a few operating parameters and you are done.

Flexible Management Configuration, commissioning, maintenance, and troubleshooting can be done locally or remotely. There are no physical switches or adjustments. The Full-Duplex Guardian allows for simultaneous reception and transmission of data and feature dual ports. All Full-Duplex models and the 900 MHz Dual-Port model provide a receive antenna connector allowing for unique customer applications requiring additional receive filtering, external PA(s), and other options.

Long Range Narrowband configurations allow better coverage over harsh terrain.

1.3 LINK CONFIGURATIONS

The Guardian allows you to program up to eight (8) different link configurations. You may choose which configuration you are using by selecting the appropriate link configuration pins. Since the pins are internally pulled High, a No Connect (NC) will result in a High state. Tie the pin to Ground (GND) to pull it Low. See Table 3 for the User Interface Port.

Table 1 Link Configurations

Link Configuration	Configuration Select 1 (internally pulled high)	Configuration Select 2 (internally pulled high)	Configuration Select 3 (internally pulled high)
1	GND ¹	GND ¹	GND ¹
2	NC ²	GND ¹	GND ¹
3	GND ¹	NC ²	GND ¹
4	NC ²	NC ²	GND ¹
5	GND ¹	GND ¹	NC ²
6	NC ²	GND ¹	NC ²
7	GND ¹	NC ²	NC ²
8 (default when no connections are made)	NC ²	NC ²	NC ²
¹ Tie the pin to Ground (GND) (Pin 5 of the User Connector) to make the pin low. ² The pin should be Not Connected (NC). The internal pull-up makes it high.			

The configurations allow you to select transmit frequencies, receive frequencies, power levels, bandwidths, RF Port configurations, Com Port configurations, Online Diagnostics and more. You may choose to program all of your units the same and let the User Connector at the install site select the proper configuration for that install.

For instance, Site A transmits at 450.05 MHz and receives at 456.05 MHz, and site B transmits at 456.05 MHz and receives at 450.05 MHz You can program Link Configuration 1 to transmit at 450.05 MHz and receive at 456.05 MHz You program Link Configuration 2 to transmit at 456.05 MHz and receive at 450.05 MHz You program the same configurations into both units. The User Port connector at Site A is wired to Link Configuration 1, and the User Port connector at Site B is wired to Link Configuration 2. If a unit fails somewhere along the line, a replacement unit with the same configuration can be plugged into either site. Link Configurations simplify radio programming and site installation.

The user can use the Default Configuration to speed up configuration programming. For instance, Site C requires an RS-232 connection, and Site D requires RS-485. All other parameters are the same for the install. By programming the desired Rx Frequency, Tx Frequency, Tx Power, etc. in the Default Configuration and then accepting default values for each Link Configuration, the User only needs to set the parameters that are different between Link Configurations. This programming by exception can save time in system configuration. Whatever you want ALL units to have, program in the Default Configuration. Program only the differences in the Link Configurations.

1.4 PHYSICAL DESCRIPTION

Guardian consists of two PCBs, one that includes the modem circuitry and the other the radio module. Both are installed in a cast aluminum case. The unit is not hermetically sealed and should be mounted in a suitable enclosure when dust, moisture, and/or a corrosive atmosphere are anticipated.

The Guardian is designed for easy installation and configuration; the Guardian features no external or internal switches or adjustments. All operating parameters are set via the setup port.

1.4.1 FRONT PANEL

The front panel has the following connections.

- (1) 8-Pin user interface block connector
- (1) 50-ohm TNC female Antenna connector
- (1) 50-ohm SMA female receive antenna connector (Dual-Port and Full-Duplex models only)
- (1) Right-angle power connector (10-30 VDC)
- (2) DE-9F RS-232 ports
- For Dual-Port or Full-Duplex Guardian connections, see Section 1.4.6.

Figure 1 Guardian Front Panel



1.4.2 LED PANEL

The LED panel has five Tri-Color LEDs. The functionality of each LED is shown in the following table.

Table 2 Guardian LED Functionality

LED	Color	Definition
Power	Green	Guardian ready, normal operations
	Amber (Solid or Blinking)	Guardian is programming
	Red	Guardian hardware fault
Status	Green	Guardian no fault conditions, normal operations
	Red	Guardian has a fault condition, check unit status
	Amber (Solid or Blinking)	Guardian detects high background noise
Rx	Green	Receiving data
	Off	
Tx	Red	Transmitting data
	Blinking Amber	The unit wants to transmit, but is inhibited

LED	Color	Definition
	Off	
RD/TD	Green Red	Receive data is being sent out of the port Transmit data is being received by the port

1.4.3 USER INTERFACE PORT

The user interface port is an 8 pin block receptacle, programmable to work with 1.8V to 5V levels. The following table shows pin-out descriptions for the User port.

Figure 2 User Interface Port Connector

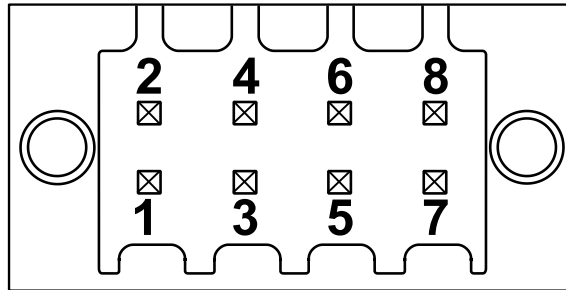

Table 3 Pin-Out for User Connector

Contact	Signal Name
1	Tx Audio in OR RS-485/422 RxB/RxD+ (input) ^{1,2}
2	Rx Audio Out OR RS-485/422 TxB/TxD+ (output) ^{1,2}
3	PTT OR RS-485/422 RxA/RxD- (input) ^{1,2}
4	RSSI Out OR RS-485/422 TxA/TxD- (output) ^{1,2}
5	Ground
6	Configuration Select 1 (internally pulled high)
7	Configuration Select 3 (internally pulled high)
8	Configuration Select 2 (internally pulled high)
¹ When RS-422 or RS-485 is configured.	
² For Half-Duplex (2 wire) connections, connect pin 1 (RxB/RxD+) to pin 2 (TxB/TxD+) and pin 3 (RxA/RxD-) to pin 4 (TxA/TxD-).	

1.4.4 SETUP AND COM PORTS

The SETUP and COM serial connections are DE-9F RS-232 ports. The pin-out for the SETUP and COM ports are shown in the table below.

Serial port considerations

- Guardian radio modem SETUP and COM ports are Data Communication Equipment (DCE) devices
- In general, equipment connected to the Guardian's SETUP / COM serial port is Data Terminal Equipment (DTE) and a straight-through cable is recommended.

Note: If a DCE device is connected to the Guardian SETUP/COM port, a null cable/adaptor is required.

Figure 3 Guardian SETUP / COM port Contact Numbering for Pin-Out

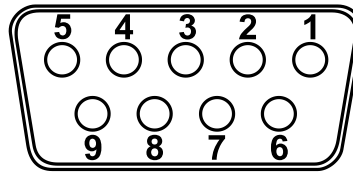

Table 4 Pin-Out for DCE SETUP and COM Port, 9 Contact DE-9 Connector

Contact	Signal Name	Signal Direction
1	Data Carrier Detect (DCD) ¹	DTE ← DCE
2	Receive Data (RxD)	DTE ← DCE
3	Transmit Data (TxD)	DTE → DCE
4	Data Terminal Ready (DTR)	DTE → DCE
5	Signal Ground (GND)	DTE — DCE
6	Data Set Ready (DSR) ²	DTE ← DCE
7	Ready to Send (RTS) ³	DTE → DCE
8	Clear to Send (CTS) ⁴	DTE ← DCE
9	Ring Indicator (RI) ⁵	DTE — DCE

¹ DCD is asserted on the COM port when a carrier is received. It is unused on the Setup port.
² Always asserted with DTR applied.
³ RTS on the COM port requests transmitter key up in RTS/CTS activation mode. It is unused on the Setup port.
⁴ CTS will be asserted when data can be sent on the COM port. It is unused on the Setup port.
⁵ Future use.

1.4.5 POWER CONNECTOR

The Guardian is supplied with a right-angle power connector (10-30 VDC). The table below shows the pin-out of the power connector.

Figure 4 Power Connector

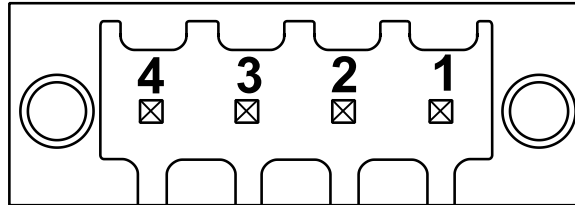

Table 5 Pin-Out of the Power Connector

Contact number (Left to Right)	Color	Description
4		Fan Power Output (5V)
3	Black	Ground
2	Red	Positive (10-30) VDC
1	White	Enable — See <i>Note</i>

Note: The white Enable line must be tied to the red positive lead of the connector for the Guardian to power up. Bringing the Enable line low is a request for the unit to power down. If the unit is writing to any non-volatile memory, it will complete the operation before powering down. It is highly recommended that you use the Enable line to power up and power down the radio.

1.4.6 ANTENNA CONNECTOR

The standard Guardian has a 50-Ohm TNC female antenna connector. This connection functions for both transmit and receive.

Warning: See 2.5 *Selecting Antenna and Lightning Arrestor Combinations for information about types of lightning arrestors to not use and good design practices to use when selecting a lightning arrestor for use with an antenna.*

The Dual-Port and Full-Duplex Guardian have a 50-Ohm TNC female antenna connector functioning for transmit (only) and a 50-Ohm SMA female antenna connector functioning for receive (only). The separate receive antenna connector allows for unique customer applications that require additional receive filtering, external PA(s), and other options.

Warning: *The transmit antenna port must not be connected directly to the receive antenna port of the Dual Port or Full Duplex Guardian. Excessive power into the receive antenna port will damage the radio. Input power to the receiver should not exceed 17 dBm (50 mW).*

To reduce potential interference, the antenna type and its gain should be chosen to ensure the effective isotropic radiated power (EIRP) is not more than required for successful communication.

1.4.7 CHASSIS DIMENSIONS

Figure 5 Dimensions of the Guardian Chassis and Mounting Plate

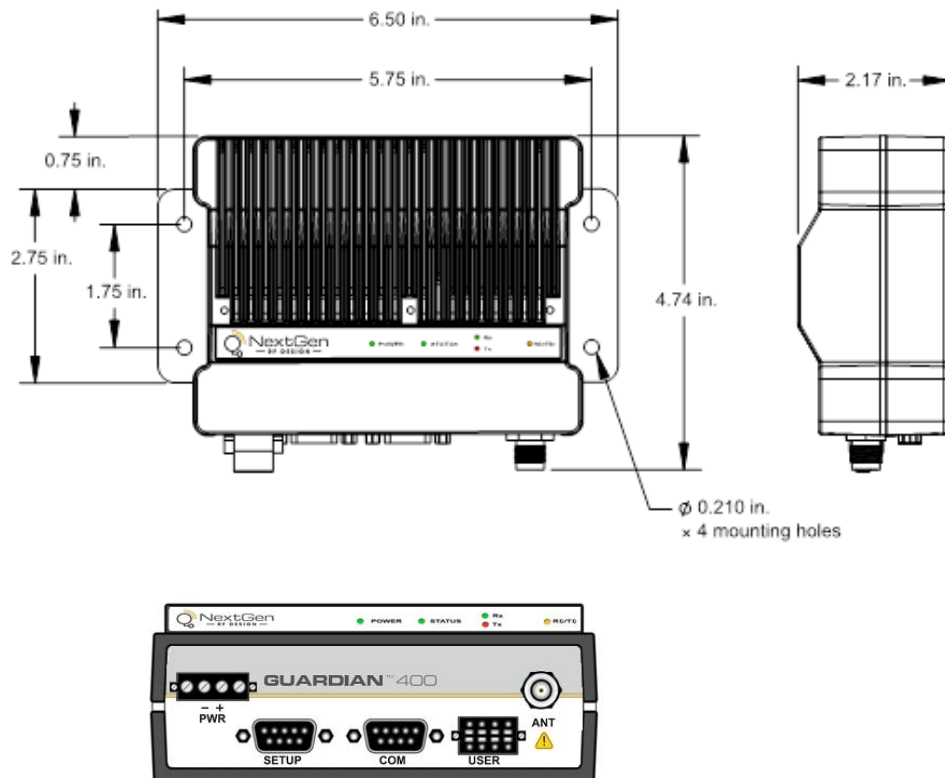

1.5 PART NUMBERS AND AVAILABILITY

1.5.1 GUARDIAN RADIO

The following table provides a breakdown of the Guardian part number 140-50X6-Y0Z.

NOTE: Obsolete models have been removed from the tables but are still supported through this manual.

Table 6 Part Number Breakdown

Model Number	Description	Frequency Range
140-5016-500	Standard VHF Guardian 100	136 - 174 MHz
140-5046-300	Standard UHF Guardian 400 Range 3	406.1 - 470 MHz
140-5046-500	Standard UHF Guardian 400 Range 5	450 - 512 MHz
140-5016-501	Full Duplex VHF Guardian 100	136 – 174 MHz
140-5026-501	Full Duplex VHF Guardian 200	215 – 240 MHz
140-5046-301	Full Duplex UHF Guardian 400 Range 3	406.1 - 470 MHz
140-5046-501	Full Duplex UHF Guardian 400 Range 5	450 - 512 MHz
140-5096-501	Dual-Port 900 MHz Guardian 900*	928 - 960 MHz

* Dual-Port 900 MHz Guardian does not support Full-Duplex operation.

1.5.2 ACCESSORIES AND OPTIONS

The following tables list Guardian Demo Kits and standard accessories tested and approved for use with the Guardian.

Table 7 Guardian Demo Kits

Description	Part Number
Guardian 100 Demo Kit* – VHF – 136-174 MHz	250-5016-500
Guardian 400 Demo Kit* – UHF - 406 – 470 MHz	250-5046-300
Guardian 400 Demo Kit* – UHF – 450 – 512 MHz	250-5046-500

* The Guardian Demo Kit includes two of each of the following: Guardians, rubber-duck antennas, adapters, attenuators, power cables, and power supplies.

Table 8 Guardian Power Cable

Description	Part Number
Guardian Power Cable	897-5008-010

Table 9 Guardian Fan Kits

Description	Part Number
Factory Installed Guardian Fan Kit	150-5008-001
Field Installed Guardian Fan Kit	150-5008-002

Table 10 Coaxial Adapter Cables

Length	Connectors	Type	Part Number
18 inches	TNC-Male to N-Male	RG-400	250-0697-103
48 inches	TNC-Male to N-Male	RG-400	250-0697-104
72 inches	TNC-Male to N-Male	RG-400	250-0697-105
18 inches	TNC-Male to N-Female	RG-400	250-0697-106

2 SYSTEM ARCHITECTURE AND NETWORK PLANNING

This section briefly discusses network architecture (including basic network types), interfacing modems and DTE, data protocols for efficient channel operation, addressing, and repeaters.

Guardian is designed to replace wire lines in SCADA, telemetry, and control applications. The RS-232 serial port allows direct connection to Programmable Logic Controllers (PLCs) or Remote Terminal Units (RTUs). A SCADA system is defined as one or more centralized control sites used to monitor and control remote field devices over wide areas. For example, a regional utility may monitor and control networks over an entire metropolitan area. Industry sectors with SCADA systems include energy utilities, water and wastewater utilities, and environmental groups.

The Guardian is intended for use in the Industrial Monitoring and SCADA market. The range of the Guardian is dependent on terrain, RF (radio frequency) path obstacles, and antenna system design. This section provides tips for selecting an appropriate site, choosing an antenna system, and reducing the chance of harmful interference.

2.1 SINGLE COVERAGE AREA

In a network topology with only a single coverage area (all units can talk to one another directly), there are several common system configurations.

The most common is for one unit to be designated as a master and the rest designated as remotes. Another system configuration is Report-by-Exception.

2.2 NETWORK ARCHITECTURE

2.2.1 POINT-TO-POINT

A point-to-point network is the simplest of all networks and may be used for connecting a pair of PCs, a host computer and a terminal, a SCADA polling master and one remote, or a wide variety of other networking applications.

Figure 6 Point-to-Point Network

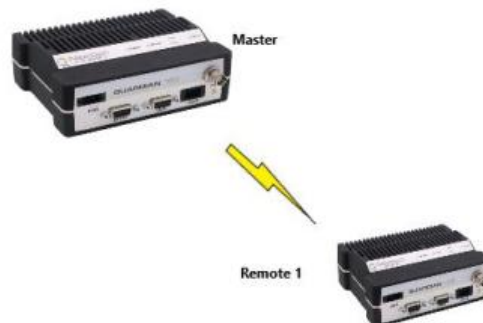

2.2.2 POINT-TO-MULTIPOINT

A Point-to-Multipoint network is a common network type used in SCADA or other polling systems. The single polling master station communicates with any number of remotes and controls the network by issuing polls and waiting for remote responses. Individual PLC/RTU remotes manage addressing and respond when their individual addresses are queried. PLC/RTU unit addresses are maintained in a scanning list stored in the host program or master terminal device at the SCADA host site. Communications equipment is transparent and does not interact with specific remotes; all data is coupled to the host on a single data line (such a network is commonly used with synchronous radio modems and asynchronous radio modems).

Figure 7 Point to Multipoint Network



2.2.3 MULTIPLE POINT-TO-POINT

A multiple point-to-point is like the point-to-multipoint system except the SCADA host has multiple serial ports that are directed to different geographic areas in the SCADA system.

2.2.4 PEER-TO-PEER

A Peer-to-Peer network is generally used for device-to-device communications among a number of stations. This network requires full addressing capability on the part of the data equipment (DTE). If the distances involved for any link or links are too great for a single radio hop, they can be extended by means of repeaters without affecting the basic network design.

2.2.5 STORE AND FORWARD

Store and forward are a common technique where a data transmission is sent from one device to a receiving device but first passes through a relaying device. The device is typically an RTU, or PLC used by the message service to store the received message then it transmits the message to the intended recipient.

2.2.6 NETWORK USING A GUARDIAN FOR ONLINE DIAGNOSTICS

The Network Using a Guardian for Online Diagnostics configuration has the following characteristics.

- Master station may be full duplex (duplexer dual antennas required), half duplex or simplex.
- Accumulated online diagnostics are available at a monitoring site (monitoring site must be in range of all remotes).
- Online Diagnostics are available in real time at the monitoring site.
- Remote Offline Diagnostics, statistics, and control are available from the monitoring site by temporarily disabling network activity (best if using a Master Station Antenna System).

Online diagnostics are accumulated in the monitoring Guardian for the last 15 stations heard. This information may be viewed using the Online Diagnostics utility. For larger networks, the Guardian can output raw diagnostic data through the Setup port which may be interpreted for network management by the Field Programming Software Online Diagnostics utility or by a user-supplied software program. Contact your sales representatives for more information.

2.3 UNDERSTANDING RF PATH REQUIREMENTS

Radio waves are propagated when electrical energy produced by a radio transmitter is converted into magnetic energy by an antenna. Magnetic waves travel through space. The receiving antenna intercepts a small amount of this magnetic energy and converts it back into electrical energy that is amplified by the radio receiver. The energy received by the receiver is called the Received Signal Strength Indication (RSSI) and is measured in dBm.

A radio modem requires a minimum amount of received RF signal to operate reliably and provide adequate data throughput. This is the radio's receiver sensitivity. In most cases, spectrum regulators will define or limit the amount of signal that can be transmitted, and it will be noted on the FCC license. This is the effective isotropic radiated power (EIRP). Transmitted power decays with distance and other factors as it moves away from the transmitting antenna.

2.4 SITE SELECTION AND SITE SURVEY

2.4.1 SITE SELECTION

For a successful installation, careful thought must be given to selecting the site for each radio. These requirements can be quickly determined in most cases. Suitable sites should provide the following.

- Protection from direct weather exposure.
- A source of adequate and stable primary power
- Suitable entrances for antenna, interface, or other cabling.
- Antenna location with an unobstructed transmission path to all remote radios in the system.

2.4.2 SITE SURVEY

A Site Survey is an RF propagation study of the RF path between two points or between one point and multiple points. UHF radio signals travel primarily by line of sight and obstructions between the sending and receiving stations will affect system performance. Signal propagation is also affected by attenuation from obstructions such as terrain, foliage, or buildings in the transmission path. A Site Survey is recommended for most projects to determine the optimal RF paths for each link. This is especially true when more than one RF coverage area is required. A Site Survey will determine the best unit location for the Relay Points.

2.5 SELECTING ANTENNA AND LIGHTNING ARRESTOR COMBINATIONS

RF engineers and installers have seen many types of radio installations over the years, and they know there are certain details that must not be overlooked at any installation. Most radio installations contain some form of lightning protection. However, the wrong combination of antenna and lightning arrestor can create high voltage transients on the radio's antenna port having devastating impacts on the life and reliability of modern-day radio equipment.

2.5.1 LIGHTNING ARRESTOR OVERVIEW

Lightning arrestors can take many forms. But some of the most common lightning arrestors use gas discharge tubes that turn on when the voltage across their terminals exceeds the specified threshold. Under normal conditions, these devices have very high impedance and no current flows through the device. When the turn on voltage threshold is exceeded, the gas discharge tube turns on instantaneously and becomes a short.

This functionality works well to limit the magnitude of a transient from a nearby lightning discharge. However, it can have extremely negative consequences if a gas discharge lightning arrestor is used with the wrong antenna.

2.5.2 ANTENNA OVERVIEW

Antennas can come in just about any shape or size. However, there is one parameter that the system designer should not overlook, especially if the radio installation uses gas discharge tube lightning arrestors. The parameter is the DC grounding of the active element in the antenna.

A DC grounded antenna will measure 0 ohms from the active element to ground when tested with an ohmmeter. One way to test this is to connect the ohmmeter from the center conductor to ground of the RF cable that is attached directly to the antenna. This will read as a short for a DC grounded antenna, and as an open for a non-DC grounded antenna. Note: Some antenna datasheets are misleading and will indicate the antenna is DC grounded. However, the datasheet may be referring to the body of the antenna and not necessarily the active element. For this reason, it is best to measure the antenna you plan to use to verify the active element is DC grounded.

2.5.3 THE WRONG COMBINATION

The combination of a DC open antenna and a DC blocked gas discharge tube lightning arrestor creates a situation where static charge can build up slowly on the active element of the antenna. Static charge can be created by wind

blowing across the antenna, precipitation hitting the active element, or other environmental causes. As static charge builds up on the antenna's active element, over a period of minutes or even hours, the DC blocking capacitor inside the lightning arrester is charged.

Figure 8 Voltage buildup due to static

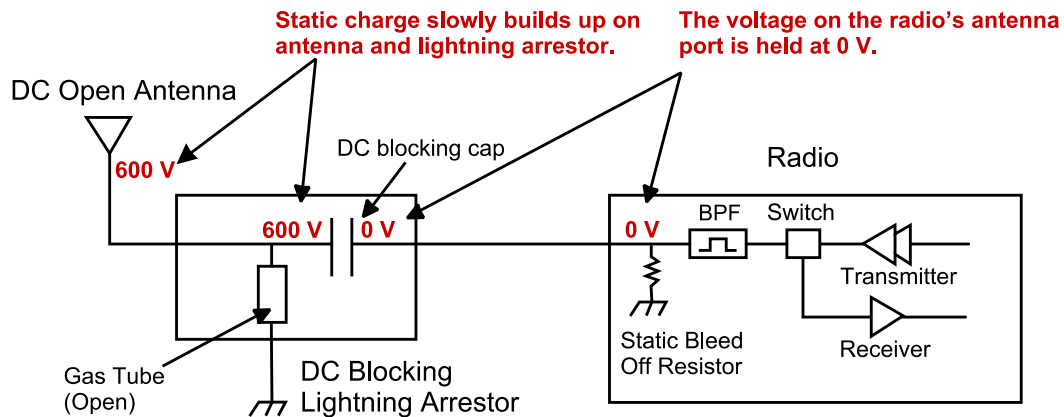

When the voltage exceeds 600V (the breakdown voltage for IS-B50LN series PolyPhasers), the gas discharge tube turns on and the antenna side of the DC blocking capacitor is immediately pulled from 600V to 0V. Since the lightning arrester's capacitor was charged to 600V, that charge must dissipate through the radio. As the capacitor discharges, a large negative transient is created on the antenna port of the radio. Positive transients can also be created if the static charge buildup on the antenna has a negative polarity.

Figure 9 Voltage Transient immediately after the gas tube turns on

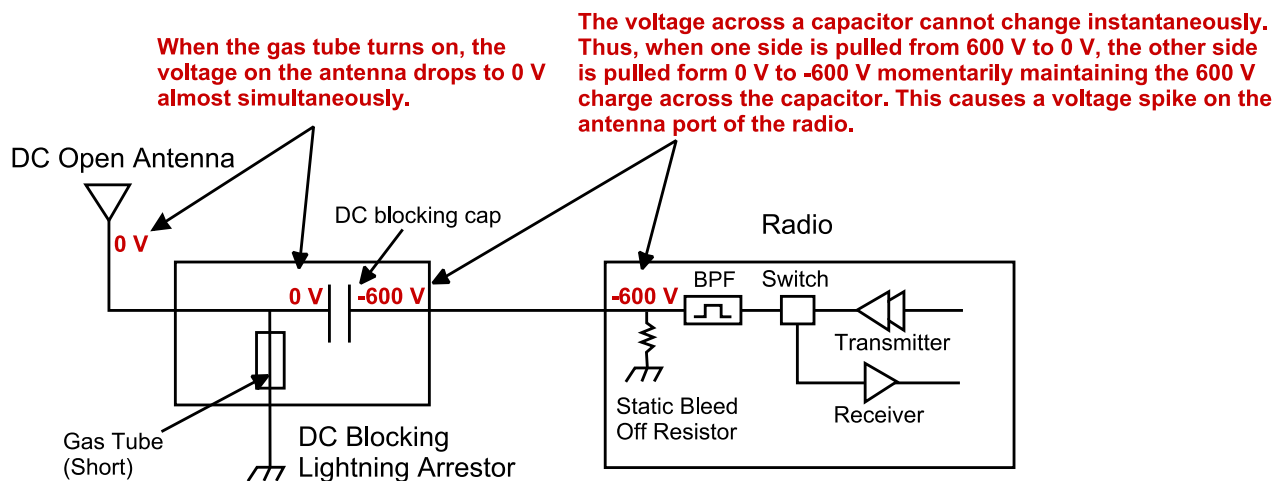

During testing, transients were measured on the antenna port of NextGen RF's Viper at voltage levels up to +/-280V. These voltage transients often have high frequency content that can easily pass through any filtering in the radio and damage components in the transmitter and receiver circuitry.

2.5.4 GOOD DESIGN PRACTICES

There are two relatively easy ways to avoid creating large transients due to static buildup on an antenna and the subsequent firing of the gas discharge tube in the lightning arrestor. Following either or both recommendations below will eliminate this potential problem.

1. Use antennas with a DC grounded active element. Antennas can easily be tested, by using an ohm meter, to measure the resistance from the center conductor to the ground of the RF cable that is directly attached to the antenna. The ohmmeter should indicate a short. (Some antenna designs, such as folded dipole or folded dipole Yagi antennas, inherently have a DC ground on the active element due to the nature of the antenna design.)
2. Use a lightning arrestor that does not have a gas discharge tube. PolyPhaser makes several DC blocked lightning arrestors that have an inductor to ground instead of a gas tube. These lightning arrestors will not allow the static to build up on the antenna, and there is no gas tube that can trigger causing a transient into the antenna port of the radio. The following lightning arrestors, manufactured by PolyPhaser, have inductors to ground instead of gas tubes:
 - a. PolyPhaser Part Number: VHF50HN Frequency Range: 100MHz - 512MHz, 750W
 - b. PolyPhaser Part Number: TSX-NFF Frequency Range: 700MHz - 2.7GHz, 750W

Tip: Lightning arrestors that use gas tubes will normally specify a “Turn-On Voltage” in the data sheet. If you see this specification in the datasheet, it is likely that the lightning arrestor has a gas discharge tube. If you are still unsure, contact the manufacturer.

2.6 SELECTING ANTENNA AND FEEDLINE

The Guardian can be used with a variety of antenna types. The exact style used depends on the physical size and layout of a system. The Guardian device has been tested and approved with antennas having a maximum gain of 10 dBi.

2.6.1 ANTENNA GAIN

Antenna gain is usually measured in comparison to a dipole. A dipole acts much like the filament of a flashlight bulb: it radiates energy in almost all directions. One bulb like this would provide very dim room lighting. Add a reflector capable of concentrating all the energy into a narrow angle of radiation and you have a flashlight. Within that bright spot on the wall, the light might be a thousand times greater than it would be without the reflector. The resulting bulb-reflector combination has a gain of 1000, or 30 dB, compared to the bulb alone. Gain can be achieved by concentrating the energy both vertically and horizontally, as in the case of the flashlight and Yagi antenna. Gain can also be achieved by reducing the vertical angle of radiation, leaving the horizontal alone. In this case, the antenna will radiate equally in all horizontal directions, but will take energy that otherwise would have gone skywards and use it to increase the horizontal radiation.

The required antenna impedance is 50 ohms. To reduce potential radio interference, the antenna type and its gain should be chosen to ensure the effective isotropic radiated power (EIRP) is not more than required for successful communication.

Several FCC-approved antennas have been tested for use with the Guardian. Similar antenna types from other manufacturers are equally acceptable. It is important to follow the manufacturer’s recommended installation procedures and instructions when mounting any antenna.

2.6.2 OMNI-DIRECTIONAL ANTENNA

In general, an omnidirectional antenna should be used at a master station and Relay Points. This allows equal coverage to all of the remote locations. Omni directional antennas are designed to radiate the RF signal in a 360-degree pattern around the antenna. Short range antennas such as folded dipoles and ground independent whips are used to radiate the signal in a ball shaped pattern while high gain omni antennas, such as a collinear antenna, compress the RF radiation sphere into the horizontal plane to provide a relatively flat disc shaped pattern that travels further because more of the energy is radiated in the horizontal plane.

2.6.3 YAGI ANTENNA

At remote locations (not used as a Relay Point), a directional Yagi is generally recommended to minimize interference to and from other users.

2.6.4 VERTICAL DIPOLES

Vertical dipoles are very often mounted in pairs, or sometimes in groups of three to four, to achieve even coverage and to increase gain. The vertical collinear antenna usually consists of several elements stacked one above the other to achieve similar results.

Table 11 Antenna Types

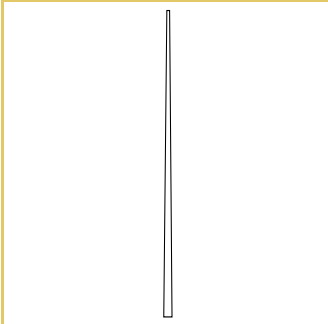
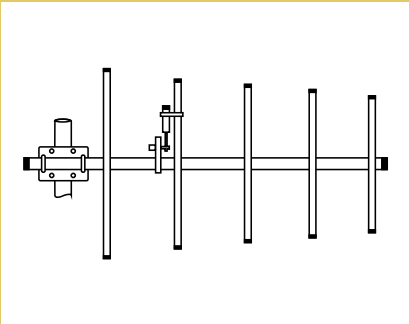
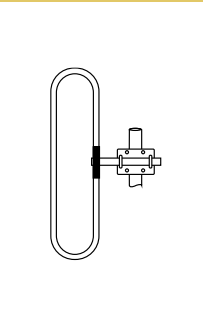
Omni (Vertical Collinear)	Yagi	Vertical Dipole
		

2.6.5 FEEDLINE

The choice of feedline should be carefully considered. Poor quality coaxial cables should be avoided, as they will degrade system performance for both transmission and reception. The cable should be kept as short as possible to minimize signal loss. See the following table for a list of feedline recommendations.

Table 12 Transmission Loss (per 100 Feet)

Cable Type	Frequency Range		
	VHF	UHF	900 MHz
LMR-400	1.5 dB	2.7 dB	3.9 dB
1/2" Heliac	0.68 dB	1.51 dB	2.09 dB
7/8" Heliac	0.37 dB	0.83 dB	1.18 dB
1-5/8" Heliac	0.22 dB	0.51 dB	0.69 dB

Outside cable connections should have a weather kit applied to each connection to prevent moisture. Feedline connections should be routinely inspected to minimize signal loss through the connection. A 3 dB loss in signal strength due to cable loss and/or bad connections represents a 50% reduction in signal strength.

2.6.6 RF EXPOSURE COMPLIANCE REQUIREMENTS

The Guardian radio is intended for use in the Industrial Monitoring and Control and SCADA markets. The Guardian unit must be professionally installed and must ensure a minimum separation distance listed in the table below between the radiating structure and any person. An antenna mounted on a pole or tower is the typical installation and in rare instances, a 1/2-wave whip antenna is used.

Table 13 RF Exposure Compliance Minimum Safety Distances

Minimum Safety Distance	Antenna Gain		
	5 dBi	10 dBi	15 dBi
VHF at maximum power	123 cm	218.8 cm	389 cm
UHF at maximum power	105.7 cm	188 cm	334.4 cm
900 MHz at maximum power	63.8 cm	115 cm	201.7 cm

Note: *It is the responsibility of the user to guarantee compliance with the FCC MPE regulations when operating this device in a way other than described above.*



RF Exposure

The Guardian serial radio uses a low power radio frequency transmitter. The concentrated energy from an antenna may pose a health hazard. People should not be in front of the antenna when the transmitter is operating.

The installer of this equipment must ensure the antenna is located or pointed such that it does not emit an RF field more than Health Canada limits for the general population. Recommended safety guidelines for the human exposure to radio frequency electromagnetic energy are contained in the Canadian Safety Code 6 (available from Health Canada) and the Federal Communications Commission (FCC) Bulletin 65.

Any changes or modifications not expressly approved by the party responsible for compliance (in the country where used) could void the user's authority to operate the equipment.

2.7 TERRAIN AND SIGNAL STRENGTH

A line of sight (LOS) path between stations is highly desirable and provides the most reliable communications link in all cases. A line-of-sight path can often be achieved by mounting each station antenna on a tower or other elevated structure that raises it high enough to clear surrounding terrain and other obstructions.

The requirement for a clear transmission path depends on the distance to be covered by the system. If the system is to cover a limited distance, say 3-5 miles, then some obstructions in the transmission path may be tolerable. For longer-range systems, any obstruction could compromise the performance of the system, or block transmission entirely.

The signal strength (RSSI) at the receiver must exceed the receiver sensitivity by an amount known as the fade margin to provide reliable operation under various conditions. Fade margin (expressed in dB) is the maximum tolerable reduction in received signal strength, which still provides an acceptable signal quality. This compensates for reduced signal strength due to multi-path, slight antenna movement or changing atmospheric losses. NextGen RF recommends a 30 dB fade margin for most projects. The following table shows the RSSI versus Reliability.

Table 14 RSSI Reliability

RSSI	Reliability
-100 dBm	Approximately 50% reliability. Fading may cause frequent data loss.
-90 dBm	Approximately 90% reliability. Fading will cause occasional data loss
-80 dBm	Approximately 99% reliability. Reasonable tolerance to most fading.
-70dBm	Approximately 99.9% reliability with high tolerance to fading.

2.8 RADIO INTERFERENCE

Interference is possible in any radio system. However, since the Guardian is designed for use in a licensed system, interference is less likely because geographic location and existing operating frequencies are normally considered when allocating frequencies.

The risk of interference can be further reduced through prudent system design and configuration. Allow adequate separation between frequencies and radio systems. Keep the following points in mind when setting up your radio system.

- a. Systems installed in lightly populated areas are least likely to encounter interference, while those in urban and suburban areas are more likely to be affected by other devices.
- b. Directional antennas should be used at the remote end of the link. They confine the transmission and reception pattern to a comparatively narrow beam, which minimizes interference to and from stations located outside the pattern.
- c. If interference is suspected from another system, it may be helpful to use antenna polarization opposite to the interfering system's antennas. An additional 20 dB (or more) of attenuation to interference can be achieved by using opposite antenna polarization.
- d. Check with your NextGen RF sales representative or NextGen RF Technical Services for additional options. The Technical Services group has qualified personnel to help resolve your RF issues.

3 SETUP AND CONFIGURATION

It is easy to set up a Guardian network to verify basic unit operation and experiment with network designs and configurations.

3.1 INSTALL THE ANTENNA

An Rx/Tx antenna is required for basic operation. For demo units only, connect the antenna as shown in the following figure to provide stable radio communications between demo devices.

Figure 10 Demo Antenna Assembly

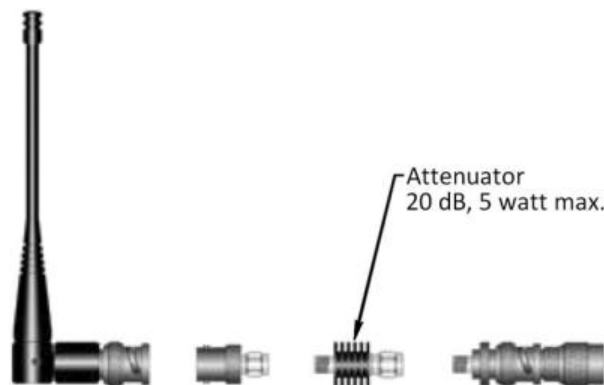

Note: It is important to use attenuation between all demo units in the test network to reduce the amount of signal strength in the test environment.

3.2 MEASURE AND CONNECT PRIMARY POWER

Primary power for the Guardian must be within 10-30 VDC and be capable of providing a minimum of 10-watt supply for the Tx at 1 W, 40-watt supply for Tx at 5 W, or 60 watt supply for Tx at 10 W. (In Guardian Demo Kits, a power supply with spring terminals is provided with each unit.) Observe proper polarity when connecting the cables to the power supply. (White wire must be connected to red wire or B+ supply.)

3.3 INSERTING WIRES INTO USER PORT CONNECTOR

1. Insert 2.5 mm Insertion Tool (NextGen RF PN 250-5006-001) into the wire-release slot. Do not twist the Insertion Tool.

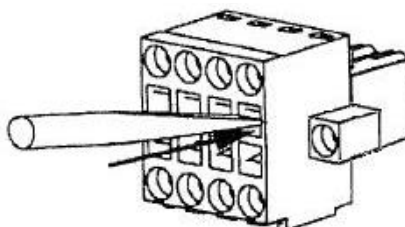

2. Keeping the Insertion Tool in place, insert wire (28 AWG minimum, 18 AWG maximum) into the wire hole.

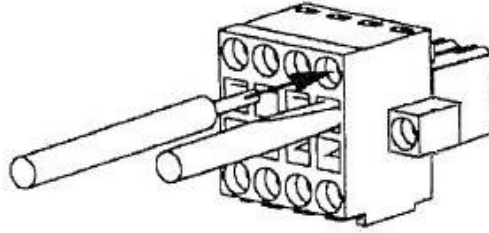

3. Remove Insertion Tool. Check wire connection.

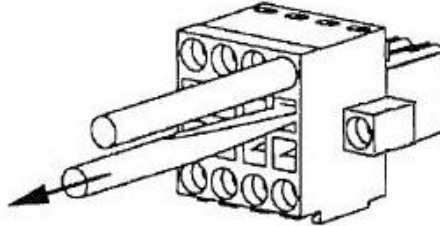

3.4 CONNECT GUARDIAN TO PROGRAMMING PC

Connection to a Guardian is established through an RS-232 (straight through) or (non-null) cable connected to the setup port of the Guardian and the COM port of the PC.

3.5 GUARDIAN FIELD PROGRAMMING SOFTWARE

Operating characteristics of the Guardian are configured by the Field Programming Software. Offline Diagnostics and Online Diagnostics give access to Offline Diagnostics and commands (local and remote) and online diagnostics monitoring. Programming software is Microsoft Windows® based and requires a Windows 98 or newer operating system. Context sensitive help and printable help files are provided with this program.

The Guardian requires the use of the Field Programming Software for configuration, adjustment, and diagnostics.

4 UNIT STATUS

In addition to unit status information provided by the five tricolor LEDs in the LED Panel, unit status information is also displayed in the Diagnostics pane of the User Configuration window (page 26 for Modem mode or page 35 for Loader Mode) of the Guardian Field Programming Software, and is explained in Chapter 5.

4.1 UNIT IDENTIFICATION AND STATUS

Each Guardian has addressing capability which is used for diagnostics and remote commands **only**.

The Long ID and Short ID with which each Guardian is configured are displayed directly under the Firmware version number in the main window of the Guardian Field Programming Software.

Figure 11 Unit Status Information

```
Firmware: $$Guardian v1.3 RELEASED Feb 26 2013 18:11:21
Long ID:   1206823                               Short ID: 551
```

If this area displays blank (for example when software is first started or initial connection has not been established), click **Version**, immediately to the left and the FPS reads this information from the Guardian and it is displayed.

4.1.1 LONG ID NUMBER

This value is assigned at the factory but may be modified using the Field Programming Software. The ID Number is used to uniquely identify the Guardian for remote commands and Offline Diagnostics. The ID Number may have values within the range of 1 to 4294967295 but **multiples of 1024 should not be used**.

4.1.2 SHORT ID

This value (maximum 1023) is the low order 10 bits of the ID Number. It is used to identify online diagnostics only. It may not be modified directly using the Field Programming Software; it is always derived from the ID Number. All units within a network should have unique Short ID numbers to avoid ambiguity in Online Diagnostics reports.

The Guardian Field Programming Software may be used to check the value of the Short ID. When setting up a network, we recommend checking each unit to make sure there is no duplication of Short ID numbers. Duplications may be resolved by changing the Long ID Number.

If ID Numbers are set within the range of 1 to 1023, the ID Number and the Short ID will always have the same value.

4.2 DIAGNOSTICS

Guardian units continually monitor and report on their environmental and operating conditions.

4.2.1 ONLINE DIAGNOSTICS

Information is automatically sent by each unit at the beginning of every transmission.

Online Diagnostics (statistics) require the use of a network configuration such as that specified in the “Network Using a Guardian for Online Diagnostics” section 2.2.6. Online diagnostics do not interfere with normal network operation. Online diagnostics provide four types of information.

- Short ID
- RSSI
- Temperature
- Battery
- Forward Power
- Reverse Power
- Time

See section 5.16 for more about _____ in the Field Programming Software.

4.2.2 OFFLINE DIAGNOSTICS

Offline diagnostics are statistics returned in response to a specific request to a particular station. The use of this feature requires temporary suspension of user network operation. Offline diagnostics provide information that is displayed via the Offline Diagnostics utility. Offline Diagnostics gather and display the following.

- Battery Voltage
- Analog V_{CC}
- Temperature
- RSSI Level
- Forward Power
- Reverse Power
- Preamble Good
- Preamble Total
- Preamble DCD

See section 5.15 for more about _____ in the Field Programming Software.

4.2.3 REMOTE COMMANDS

Remote commands that may be sent using the Offline Diagnostics utility include:

- Sample network statistics (monitoring online diagnostics)
- Get statistics (diagnostics)

5 GUARDIAN FIELD PROGRAMMING SOFTWARE

5.1 INTRODUCTION

The Guardian Field Programming Software provides programming and diagnostics for the Guardian wireless modem. The Field Programming Software allows the user to edit and program user programmable settings, interactively tune modem and RF parameters, and monitor diagnostic data from the Guardian. See the following figure for the Guardian Field Programming Software startup window.

Figure 12 Guardian Field Programming Software Startup Window



This manual assumes the Field Programming Software (included with your device) has been installed on the user's PC with at least one operational serial COM Port available.

5.2 GUARDIAN PROGRAMMER WINDOW

The following figure displays the main window of the Guardian Programmer software for field programming the Guardian.

Figure 13 Guardian Programmer Window

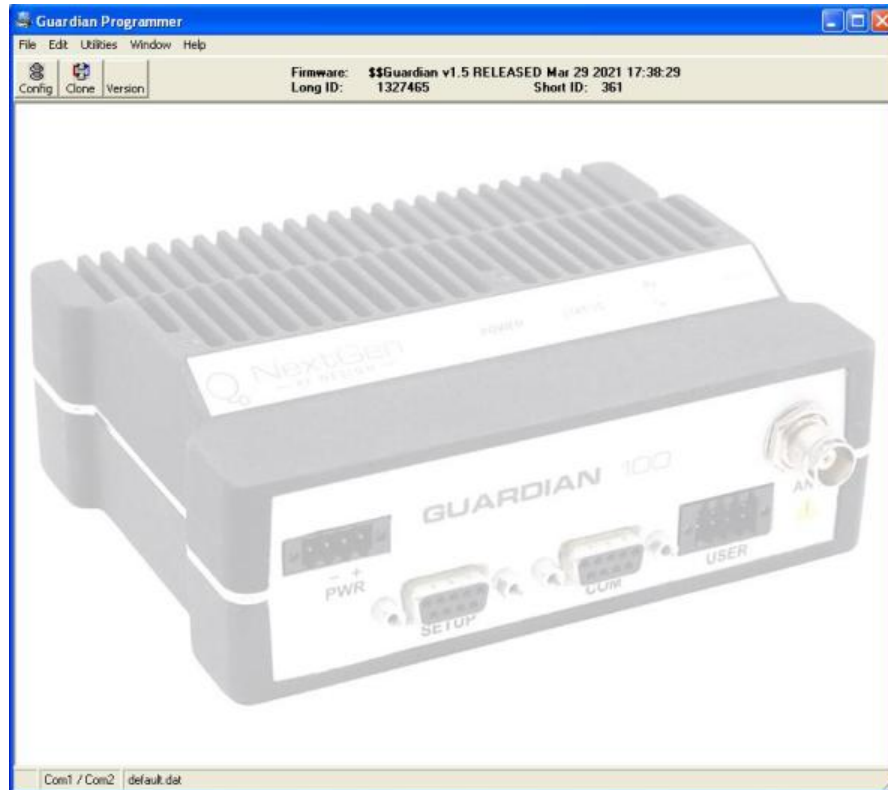

Guardian programming is through the PC's Primary COM Port. Primary and secondary COM ports are configured with the Field Programming Software. The programming cable (included in the Demo Kit) is connected from the Setup Port on the Guardian to the PC's COM port configured as the Primary Port.

5.3 PORT SETTINGS

The Port Settings window of the Field Programming Software is accessed by selecting Port Settings from the Utilities menu of the main Guardian Programmer window (above). Tabbed panels in the Port Settings window (see the following figure) are used to configure the PC's serial COM ports. COM port assignments are displayed in the status bar at the bottom of the main Guardian Programmer window.

Figure 14 Port Settings Window

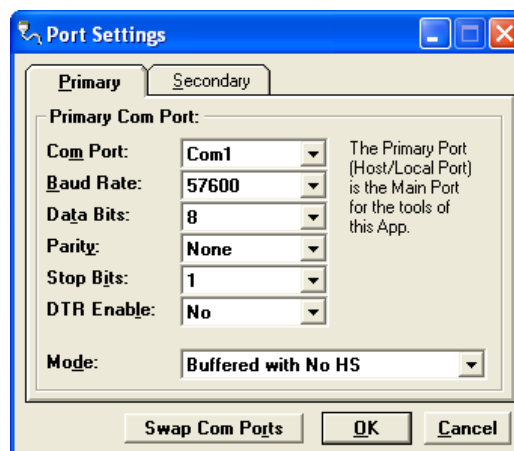

COM Port

Selects COM Port number (1- 32) for Primary and Secondary COM Ports. **Default is COM1.**

Baud Rate

Selects the communication speed for Primary and Secondary COM Ports. **Default is 57600 bps.**

Data Bits

Selects number of data bits (7 or 8) transmitted or received for the Primary and Secondary COM Ports. **Default is 8.**

Parity

Selects transmission or reception of any Parity bits for the Primary and Secondary COM Ports. **Default is None.**

Stop Bits

Selects number of Stop Bits (1 or 2) transmitted or received for the Primary and Secondary COM Ports. **Default is 1.**

DTR Enable

Used to assert DTR (Data Terminal Ready) line of the RS-232 Port when the port is open for the Primary and Secondary COM Ports. **Default is NO.**

Swap COM Ports

Clicking the Swap Com Ports button moves the Secondary COM Port settings to the Primary COM Port (and moves the Primary COM Port to the Secondary settings). Since Guardian programming is done through the Primary COM Port, this is useful when two units are connected to the Primary and Secondary COM Ports. A Swap COM Ports allows the second unit to be programmed without switching programming cables.

5.3.1 PRIMARY AND SECONDARY PORT SETTINGS COMMUNICATIONS MODES

The Mode menu located near the bottom of the Port Settings window (see Figure 14) configures the communications mode for the Primary and Secondary PC Port. See the following table for Communication Mode configurations.

Table 15 Communication Modes

Mode	Description
Sync/ESC with No HS	Sends data using Sync/byte-stuffing protocol without handshaking.
Buffered with No HS	Sends buffered data without handshaking (this mode required for DOX operation.) This is the Default.
Sync/Esc with RTS/CTS HS	Sends data using the Sync/Esc byte-stuffing protocol with RTS/CTS hardware handshaking.
Buffered with RTS/CTS HS	Sends buffered data with RTS/CTS hardware handshaking.
Sync/Esc with Flow Control HS	Sends data using the Sync/Esc byte-stuffing protocol with flow control handshaking.
Buffered with Flow Control HS	Sends buffered data with flow control hardware handshaking.

5.4 PORT STATISTICS

The Port Statistics window is accessed via the Utilities menu. Port Statistics show current parameters of the PC's Primary and Secondary COM Ports.

Figure 15 Port Statistics Window

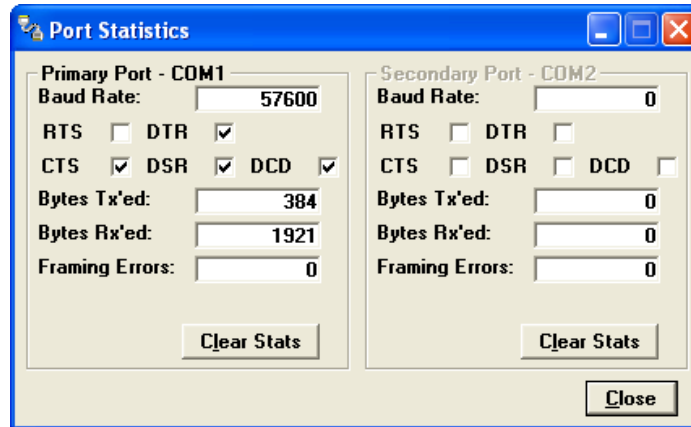

Baud Rate

Baud Rate shows the current baud rate setting for the Primary and Secondary COM ports.

RTS

RTS shows the current state of the RTS (request to send) line. RTS is an output from the PC.

DTR

DTR shows the current state of the DTR (data terminal ready) line. DTR is an output from the PC.

CTS

CTS shows the current state of the CTS (clear to send) line. CTS is an input to the PC.

DSR

DSR shows the current state of the DSR (data set ready) line. DSR is an input to the PC.

DCD

DCD shows the current state of the DCD (data carrier detect) line. DCD is an input to the PC.

Bytes Tx'ed

Bytes Transmitted shows the number of bytes (characters) transmitted since the port was last opened or cleared.

Bytes Rx'ed

Bytes Received shows the number of bytes (characters) received since the port was last opened or cleared.

Framing Errors

Framing Errors shows the number of Framing Errors received since the port was last opened or cleared.

5.5 USER CONFIGURATION — MODEM MODE

The **User Configuration** window is accessed from the **Utilities** menu or the **Config** button on the tool bar. To put the Guardian in Modem mode, select **Modem** in the **Mode** field.

Figure 16 User Configuration Window – Modem Mode

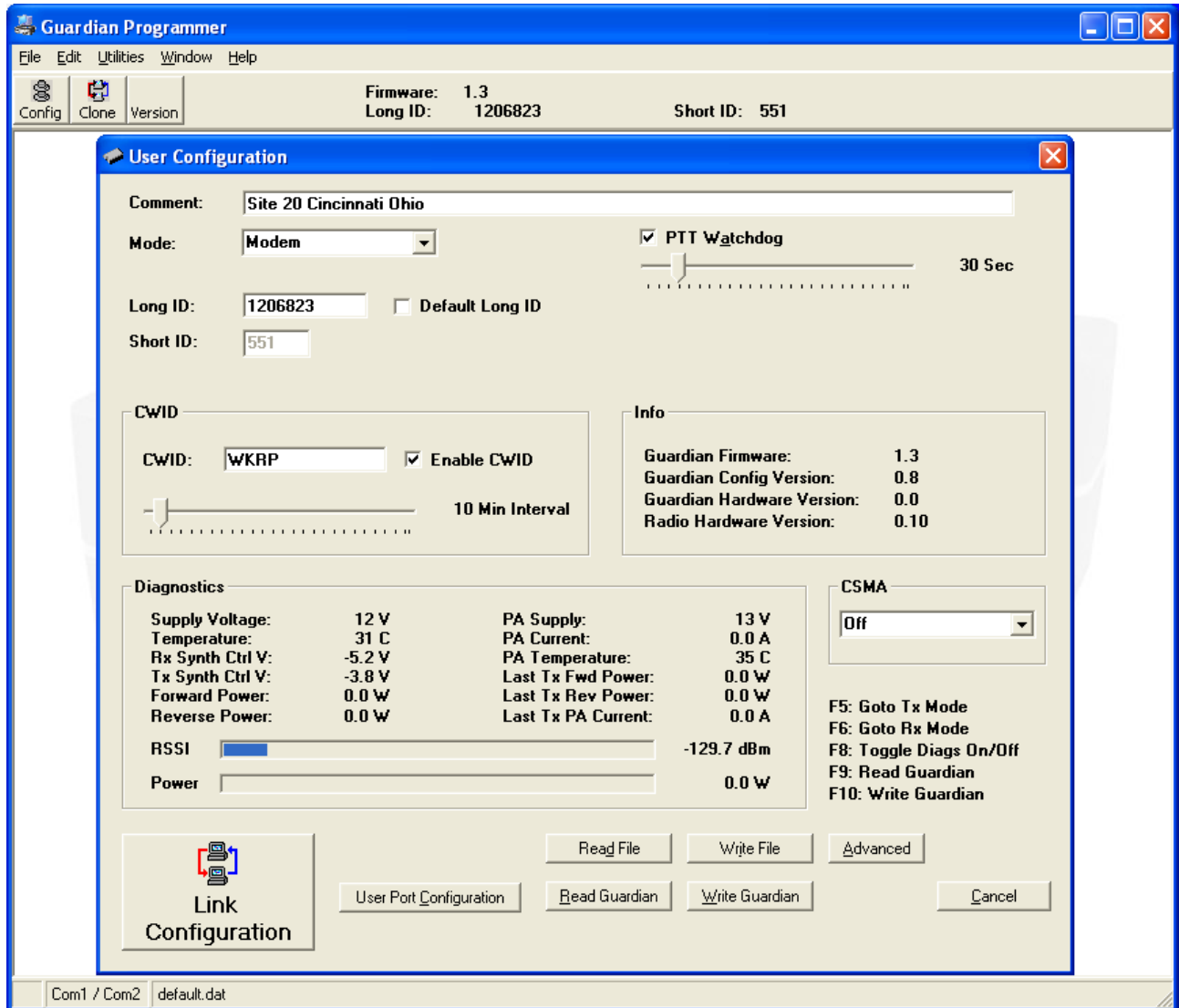

Comment

The Comment field can be used as a notepad (i.e., customer name, location, technical info, etc. can be entered in this field). Comments are text up to 80 characters including spaces.

Mode

Selects whether the Guardian will operate as a Digital Modem or an Analog Loader.

Long ID

The electronic ID Number is a unique number assigned at the factory. This number may be changed in the case of duplication by unchecking the Default Long ID check box. The ID Number is used by the programmer for remote addressing and diagnostics. The range of this field is 1 to 4294967295 but multiples of 1024 should not be used. A

multiple of 1024 results in a Short ID of 0. If the ID Number is within the range of 1 to 1023, the Short ID will be the same.

Note: This ID is not the same as the printed serial number. Use the printed serial number to verify if the unit is under warranty.

Short ID

The Short ID is derived from the longer ID Number. It is used to identify units and minimizes the time required to transmit Online Diagnostics. The Short ID of each unit in a network must be unique if Online or Offline Diagnostics will be used. Since the Short ID is derived from the ID Number, no entry is allowed in this field. The range of the Short ID is 1 to 1023.

PTT Watchdog

Check to enforce a maximum transmit time or uncheck for unlimited transmit time. This is used to protect against a “stuck” transmitter. The slider bar lets you adjust the transmit time for PTT watchdog from 0 to 255 seconds.

CWID

Some regulatory agencies require a station identification. The Guardian offers a Morse Code (CW) identifier that will identify the unit on the first transmission and at periodic intervals after that. This field is used to set the Station ID (CWID) or FCC Call Sign for the Guardian Modem.

If enabled, the Guardian will transmit the CWID string as Morse Code at the time interval chosen on the slider. A time interval between 1 and 255 minutes is available.

Station ID is a combination of letters and numbers and the characters: space, exclamation point (!), Dollar Sign (\$ - SX), Ampersand (& - AS Wait), Apostrophe ('), parenthesis, plus (+), hyphen (-), comma (,), period (.), slash (/). The CWID may be up to 13 characters in length.

Info

Displays Guardian firmware and hardware version information.

Diagnostics

Displays Guardian unit diagnostics and health status.

Carrier Sense Multiple Access (CSMA)

The Guardian Modem may be programmed to check for traffic on the RF channel before beginning a transmission if enabled.

Off: Disables CSMA. Guardian will not check for traffic on RF channel before transmitting.

No Tx on RX Data: Enables CSMA. Guardian will check the RF channel for valid data before transmitting. If valid data is found, the Guardian will wait until the channel is clear before sending the data.

No Tx on RX Carrier: Enables CSMA. Guardian will check the RF channel for an RF carrier. If carrier is found, the Guardian will wait until the channel is clear before sending the data.

User Port Configuration

Used to configure the Guardian’s User Port when configured in Modem Mode.

Read File

Read a Guardian Configuration file from the PC into the Guardian Programmer.

Write File

Writes the current configuration to the selected path and filename on the PC.

Read Guardian

Click to read the configuration file from the Guardian and update the display. Same as pressing the F9 key.

Write Guardian

Click to write the current configuration to the Guardian's flash memory. Same as pressing the F10 key.

Function Keys

F5: Press F5 key to cause the Guardian to key the radio and go into transmit mode.

F6: Press F6 key to cause the Guardian to un-key the radio and go into receive mode.

F8: Press F8 key to stop the Guardian Programmer from requesting diagnostics from the Guardian setup serial port.

F9: Press F9 key to read the configuration information from the Guardian.

F10: Press F10 key to write the current configuration to the Guardian's flash memory.

5.6 LINK CONFIGURATION — MODEM MODE

The **Link Configuration** window is accessed from the **Link Configuration** button in the **User Configuration** window. Link Configuration allows the user to view and edit Guardian's Link Configurable parameters. For more information about , see Section 1.3.

Figure 17 Link Configuration Window – Modem Mode

Link Configuration

Default | Link 1 | Link 2 | Link 3 | Link 4 | Link 5 | Link 6 | Link 7 | Link 8

RF Link

Rx Frequency: 157.000000 MHz Default
Tx Frequency: 157.600000 MHz Default
Power Output: 5.0 Watts Default

Bandwidth: 12.5 kHz Default
RF Baud Rate: 4800, 2 level FSK Default
Data Bits: 8 Default
Parity: None Default
Stop Bits: 1 Default

Data Type: Enhanced Only Default
Network Type: T-96S/DL-3276

Modem Settings

Default

Online Diagnostics
 Output Online Diagnostic Data to Setup Port
 Repeater Mode (Extended T1 RTS-CTS)
 Extended Turnoff (T2)
 Rx-Only Radio
 Inverted Carrier Detect (CD)
 Dynamic Carrier Detect Off Thresholds

On: -110 dBm

COM Port

Port Baud Rate: 9600 Default
Data Bits: 8 Default
Parity: None Default
Stop Bits: 1 Default

Serial Standard

RS-232
 RS-422
 RS-485
 Full Duplex (4-Wire)

Default
TX Activation Mode

DOX
 RTS/CTS
DOX Delay: 6

Default Save Changes Cancel

The Guardian allows you to configure up to eight (8) separate Link Configurations for the unit. The Link Configuration the unit utilizes is selected by the Configuration Select lines on the User connector.

Link Configuration settings are modified from three sections on this window: Modem Settings, RF Link, and COM Port. When desired parameters in each tab window have been adjusted, click Save Changes to store the parameter information into local PC memory and close the window.

Clicking Cancel exits the window without modifying any parameters currently stored in local PC memory. Placing a check in the Default box next to a selection will force that Link Configuration selection to use the setting from the Default Configuration. Clicking the Default button at the bottom left of the window will reset all settings for the Link Configuration to the settings selected in the Default Configuration.

Figure 18 Link Configuration Window Default Tab – Modem Mode

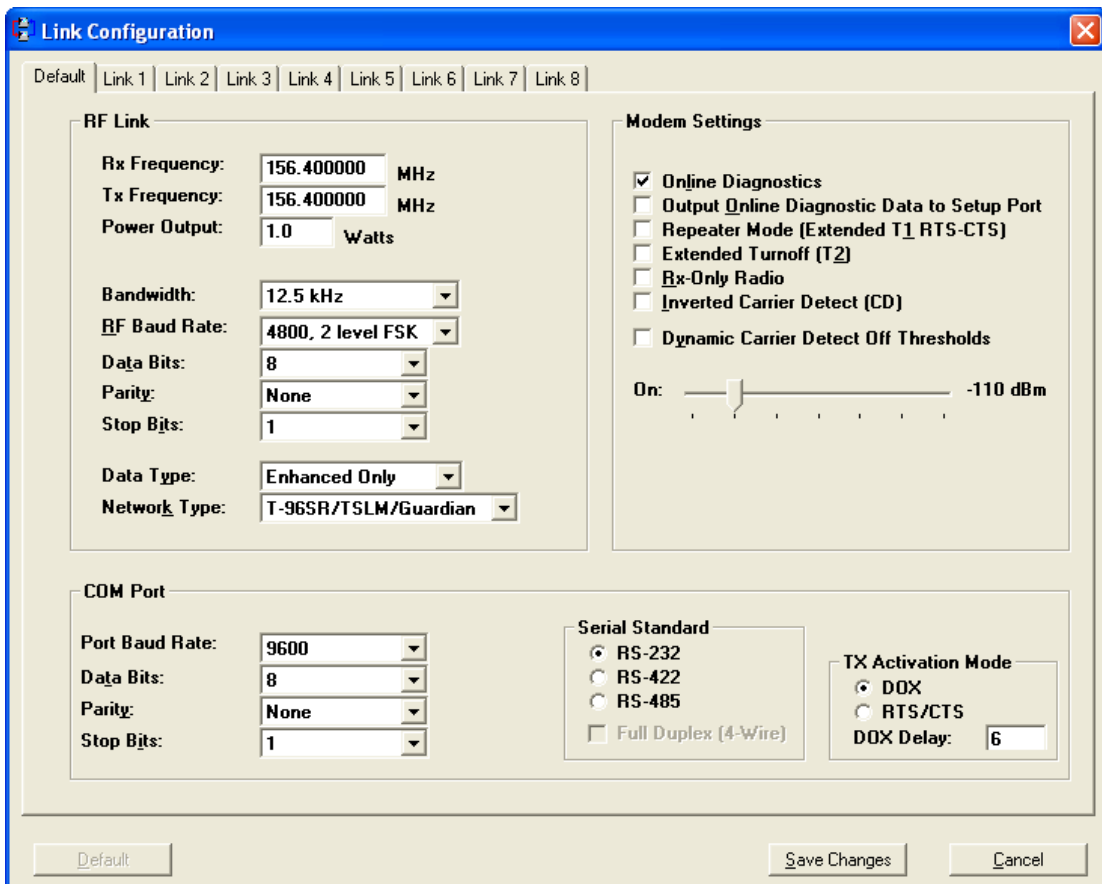

This tab is used to set all the Guardian Modem's default settings. The default settings will be used in any of the 8 links where the Default check boxes are checked.

5.6.1 MODEM SETTINGS

Figure 19 Modem Settings panel

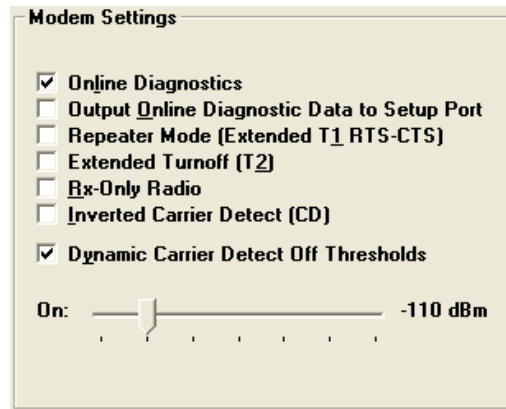

Online Diagnostics

If enabled, diagnostics information is sent at the beginning of each transmission. Diagnostics information is invisible to user data except for the increase in RTS/CTS delay of 11ms (at 9600 bits per second). **The default value is Enabled (checked).**

Note: All units in a network must use the same setting.

Diagnostics from the last 15 stations heard are stored in each unit. These values are read using the Offline or Online Diagnostics window.

Transmitted information includes:

- Short ID
- Supply Voltage (in Volts)
- Internal Temperature (in Celsius)
- Forward and Reverse Power (in Watts)
- Received Signal Strength (in dBm)

Output Online Diagnostic Data to Setup Port

Allows the user to configure the Guardian Modem to output online diagnostics through the Setup Port. **The default value is Disabled (unchecked).**

Repeater Mode (Extended T1 RTS-CTS)

The Repeater Mode option extends transmitter turn-on time to allow use in a repeater network. **The default value is Disabled (unchecked).**

Extended Turn-off (T2)

The Extended Turn-off option extends transmitter turn-off time to enforce a quiet period at the end of each transmission. Select "Enabled" if data equipment does not clearly terminate each data frame and is susceptible to extraneous bits (dribble bits) at the end of data transmission. **The default value is Disabled (unchecked).**

Values are: 4800 bits per second = 16 ms; 9600 bits per second = 8 ms; or 19200 bits per second = 4 ms

An end-of-transmission quiet period approximately 8 characters long can be invoked on the Guardian by holding its transmitter on briefly after RTS is dropped. This quiet period (which occurs between the last valid data character and any possible extraneous “noise” bits) may be of benefit to some DTE that would otherwise be adversely affected by the extraneous bits.

Rx-Only Radio

The Rx-Only Radio option instructs the modem to receive data and diagnostics from other modems only. Enabling this option disables user data delivery. **The default value for this option is Disabled (unchecked).**

Inverted Carrier Detect (CD)

Carrier Detect (CD) is a 0-5 VDC output that is triggered by the receiver squelch circuit when it senses a signal strong enough to meet the carrier sense (CS) setting. In some applications, it is desirable to use the CD line to set another radio to transmit or to control an external device by providing a ground. To accomplish this, the CD line would be inverted to provide 5-0 VDC. **The default value for this option is Disabled (unchecked).**

Dynamic Carrier Detect Off Threshold

Allows the modem to automatically adjust the Carrier Detect Off Threshold based on the RSSI while receiving data. If selected, the Carrier Detect Off level will automatically adjust to approximately 15 dB below the actual signal strength. This provides rapid detection of loss-of-carrier and minimizes or eliminates “bit dribble” at the end of transmissions.

The default value is Enabled (checked).

Recommendation: Keep Dynamic Carrier Detect Off Threshold enabled (checked) unless interference or variable signal strength (i.e., fading in a moving vehicle) causes problems.

Carrier Detect on Threshold

The sliding control allows the user to set the minimum RSSI level that the Guardian Modem will recognize as a valid carrier and begin decoding data.

5.6.2 RF LINK

The RF Link panel provides the interface for programming various radio operating parameters.

Figure 20 RF Link Panel

The screenshot shows the 'RF Link' configuration panel with the following settings:

Rx Frequency:	156.400000	MHz
Tx Frequency:	156.400000	MHz
Power Output:	1.0	Watts
Bandwidth:	12.5 kHz	
RF Baud Rate:	9600, 2 level FSK	
Data Bits:	8	
Parity:	None	
Stop Bits:	1	
Data Type:	Enhanced Only	
Network Type:	T-96SR/TSLM/Guardian	

Rx Frequency

Displays the receive frequency for the channel pair.

Tx Frequency

Displays the transmit frequency for the channel pair.

Power Output

Displays the transmit power value for the channel pair. **The default value is 5.0 Watts.** This value should not be changed from the default value unless a lower power is required to meet regulatory requirements.

Bandwidth

This field specifies whether the unit is half- or full channel (12.5 or 25 kHz).

RF Baud Rate

This field selects the Network (over-the-air) baud rate.

- When half-channel bandwidth (12.5 kHz) is selected – 4800 or 9600 bps
- When full-channel bandwidth (25 kHz) is selected – 4800, 9600, or 19200 bps

Data Bits

Number of bits making up the data word for the RF Link. Select 7 or 8. **The Default is 8.**

Parity

Select Even, Odd, Mark, Space, or None to specify the sum of bits for the RF Link. **The Default is None.**

Stop Bits

Select 1 or 2 to specify which marks the end of the serial port data byte for the RF Link. **The Default is 1.**

Data Type

Select Enhanced Only or Compatible. **The Default is Enhanced Only.**

Network Type

Select network type for devices on the network, T-96S/DL-3276, Crystal, or T-96SR/TSLM/Guardian. **The Default is T-96SR/TSLM/Guardian.**

5.6.3 COM PORT

Figure 21 COM Port Panel

The screenshot shows a configuration window titled "COM Port" with the following settings:

Port Baud Rate:	9600
Data Bits:	8
Parity:	None
Stop Bits:	1
Serial Standard:	<input checked="" type="radio"/> RS-232 <input type="radio"/> RS-422 <input type="radio"/> RS-485 <input type="checkbox"/> Full Duplex (4-Wire)
TX Activation Mode:	<input checked="" type="radio"/> DOX <input type="radio"/> RTS/CTS DOX Delay: 6

Port Baud Rate

This field selects the Guardian COM Port baud rate.

Data Bits

Number of bits making up the data word for the Guardian COM Port. Select 7 or 8. **The Default is 8.**

Parity

Select Even, Odd, Mark, Space, or None to identify the sum of bits for the Guardian COM Port. **The Default is None.**

Stop Bits

Select 1 or 2 to mark the end of the serial port data byte for the Guardian COM Port. **The Default is 1.**

Serial Standard

Select **RS-232** to use the RS-232 interface for the Guardian COM port for incoming and outgoing data.

Select **RS-422** to use the RS-422 compatible interface in the User Connector for incoming and outgoing data.

Select **RS-485** to use the RS-485 compatible interface in the User Connector for incoming and outgoing data.

The RS-422 and RS-485 interface in the Guardian is a 4-wire (2 transmit and 2 receive) interface. If your interface is also 4 wire, you may select Full Duplex (4-wire) to allow simultaneous transmission and reception of data. If you require a two-wire interface, deselect the Full Duplex (4-wire) box.

TX Activation Mode

Select DOX or RTS/CTS. **The Default is DOX mode.**

- **DOX mode:** Data is sent whenever it is present at the port. Flow control is not required. All RS-422 and RS-485 connections are run through DOX mode.
- **RTS/CTS mode:** Data is sent after the device raises the RTS and the Guardian returns a CTS signal to the device. This setting is unique to the COM Port and RS-232.

DOX Delay: If DOX mode is selected, a number may be entered to specify the length of the delay.

5.7 USER PORT CONFIGURATION — MODEM MODE

The User Port Configuration button is in the User Configuration window.

Figure 22 User Port Configuration Window – Modem Mode

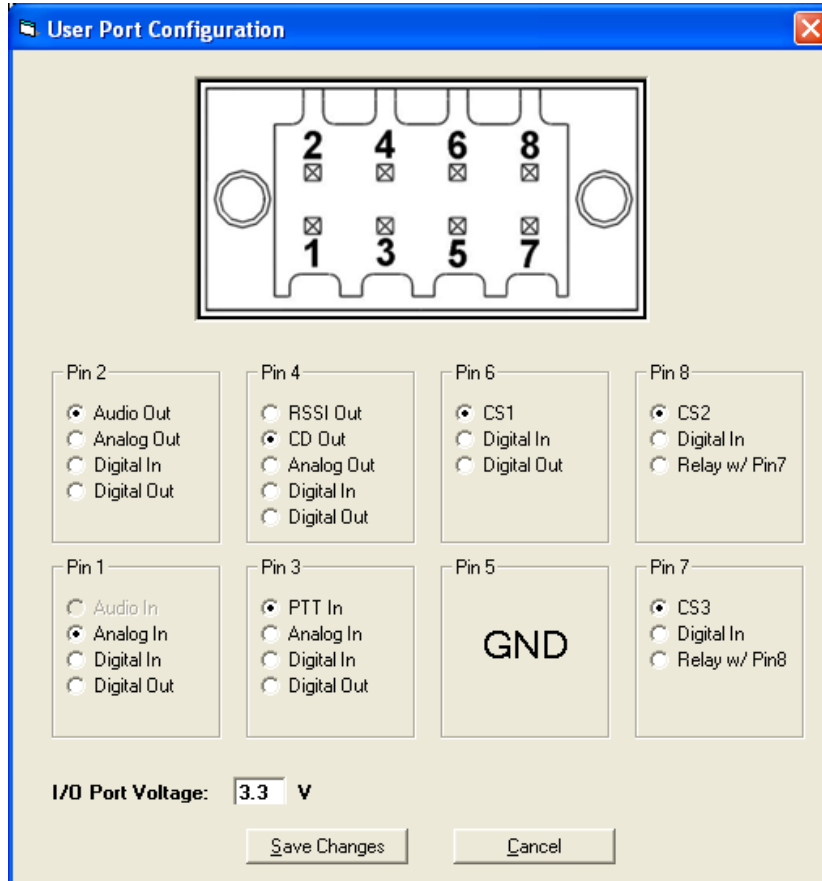

Modem User Port Configuration is used to configure the Guardian’s User Port when configured in Modem Mode. There are 8 pins on the Guardian User Port. 7 pins are available to the user and can be programmed with for different functions. Pin 5 is always ground and cannot be programmed.

Note: Pins 1 - 4 may be reserved for RS-422 / RS-485 serial port functions if the active RF Link Serial Standard is programmed to RS-422 or RS-485 in the Link Configuration window.

- **Audio Out:** Pin will be programmed as an Audio Output. Modem audio will be output from the pin.
- **Analog In:** Pin will be programmed as an Analog Input. Pin is connected to an analog to digital converter (ADC).
- **Analog Out:** Pin will be programmed as an Analog Output. Pin is connected to a digital to analog converter (DAC).
- **Digital In:** Pin will be programmed as a Digital Input. Logic level of pin can be read by the Guardian.
- **Digital Out:** Pin will be programmed as a Digital Output. Guardian can output a logic level at the programmed I/O Port Voltage.
- **RSSI Out:** Pin will be programmed as a Receive Signal Strength Indicator Output. A voltage representing the strength of the Guardian’s received RF signal will be output from the pin.
- **CD Out:** Pin will be programmed as a Carrier Detect Output. This pin will be asserted whenever the Carrier Detect conditions are met that were programmed in the Link Configuration window. The pin is normally Active High but can be made Active Low by checking the Inverted Carrier Detect check box on the Link Configuration window.
- **PTT In:** Pin will be programmed as a Push to Talk (PTT) Input that will cause the Guardian to begin transmitting. PTT In is normally Active Low but can be changed to Active High by checking the Inverted PTT check box on the Link Configuration window.

- **Relay:** Pins 7 and 8 can be opened or closed through an internal relay.
- **CS1-3:** Will be programmed as a Channel/Link Select. Pins programmed as a Channel Select will be used as binary inputs to select the desired RF Link programmed in the Link Configuration window. Pins are internally pulled high.
- **I/O Port Voltage:** Programs the input and output voltage of the pins on the Guardian User Port. Valid voltage range is from 3.3 - 5.0V. Default is 3.3V.

5.8 USER CONFIGURATION — LOADER MODE

The **User Configuration** window is accessed from the **Utilities** menu or the **Config** button on the tool bar. To put the Guardian in Loader mode, select Loader in the Mode field.

Figure 23 User Configuration Window – Loader Mode

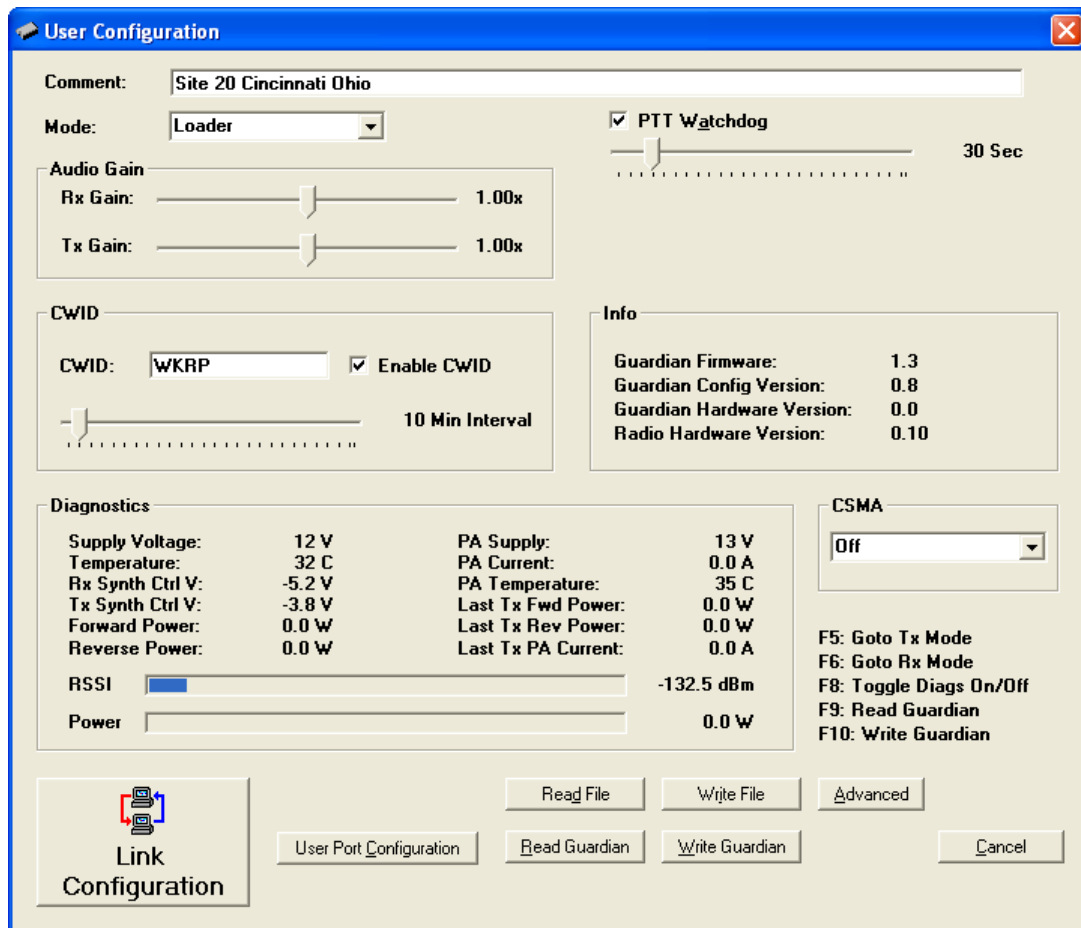

Comment

The Comment field can be used as a notepad (i.e., customer name, location, technical info, etc. can be entered in this field). Comments are text up to 80 characters including spaces.

Mode

Selects whether the Guardian will operate as a Digital Modem or an Analog Loader.

Rx Audio Gain

Adjusts the gain of the received signal from the receiver to the Guardian output pin.

Tx Audio Gain

Adjusts the gain from the Guardian audio input pin to the transmitter.

PTT Watchdog

Check to enforce a maximum transmit time or uncheck for unlimited transmit time. This is used to protect against a “stuck” transmitter. The slider bar lets you adjust the transmit time for PTT watchdog from 0 to 255 seconds.

CWID

Some regulatory agencies require a station identification. The Guardian offers a Morse Code (CW) identifier that will identify the unit on the first transmission and at periodic intervals after that. This field is used to set the Station ID (CWID) or FCC Call Sign for the Guardian Modem.

If enabled, the Guardian will transmit the CWID string as Morse Code at the time interval selected by using the slider. A time interval between 1 and 255 minutes is available.

Station ID is a combination of letters and numbers and the characters: space, exclamation point (!), Dollar Sign (\$ - SX), Ampersand (& - AS Wait), Apostrophe ('), parenthesis, plus (+), hyphen (-), comma (,), period (.), slash (/). The CWID may be up to 13 characters in length.

Info

Displays Guardian firmware and hardware version information.

Diagnostics

Displays Guardian unit diagnostics and health status.

Carrier Sense Multiple Access (CSMA)

The Guardian Modem may be programmed to check for traffic on the RF channel before beginning a transmission if enabled.

Off: Disables CSMA. Guardian will not check for traffic on RF channel before transmitting.

No Tx on Rx Data: Enables CSMA. Guardian will check the RF channel for valid data before transmitting. If valid data is found, the Guardian will wait until the channel is clear before sending the data.

No Tx on Rx Carrier: Enables CSMA. Guardian will check the RF channel for an RF carrier. If carrier is found, the Guardian will wait until the channel is clear before sending the data.

User Port Configuration

Used to configure the Guardian’s User Port when configured in Modem Mode.

Read File

Read a Guardian Configuration file from the PC into the Guardian Programmer.

Write File

Writes the current configuration to the selected path and filename on the PC.

Read Guardian

Click to read the configuration file from the Guardian and update the display. Same as pressing the F9 key.

Write Guardian

Click to write the current configuration to the Guardian’s flash memory. Same as pressing the F10 key.

Function Keys

F5: Press F5 key to cause the Guardian to key the radio and go into transmit mode.

F6: Press F6 key to cause the Guardian to un-key the radio and go into receive mode.

F8: Press F8 key to stop the Guardian Programmer from requesting diagnostics from the Guardian setup serial port.

F9: Press F9 key to read the configuration information from the Guardian.

F10: Press F10 key to write the current configuration to the Guardian's flash memory.

5.9 LINK CONFIGURATION — LOADER MODE

The **Link Configuration** window is accessed from the **Link Configuration** button in the **User Configuration** window. Link Configuration allows the user to view and edit Guardian's Link Configurable parameters.

Figure 24 Link Configuration Window – Loader Mode

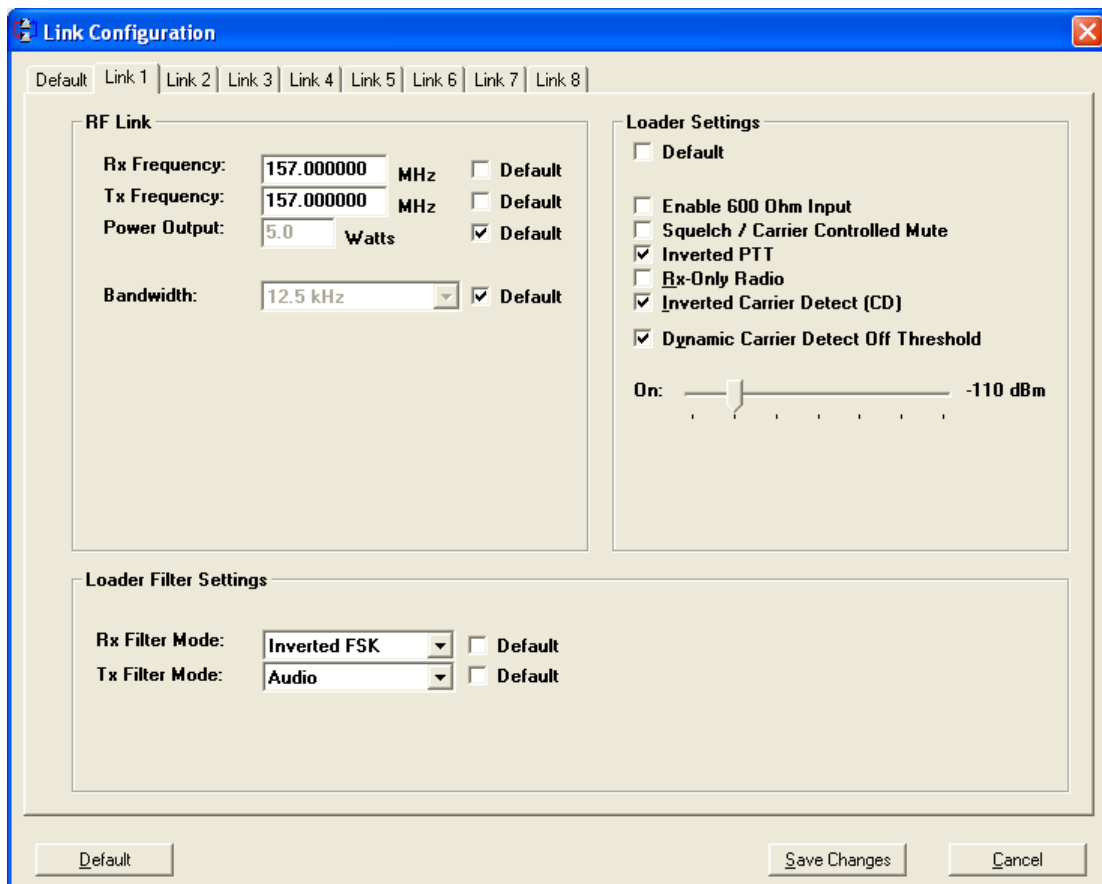

Link 1 – 8: These tabs are used to set the different programmable options for each of the Guardian's programmable links. Each link can use the settings from the Default tab by checking the Default check box, or of saving its own individual custom settings.

Figure 25 Link Configuration Window Default Tab – Loader Mode

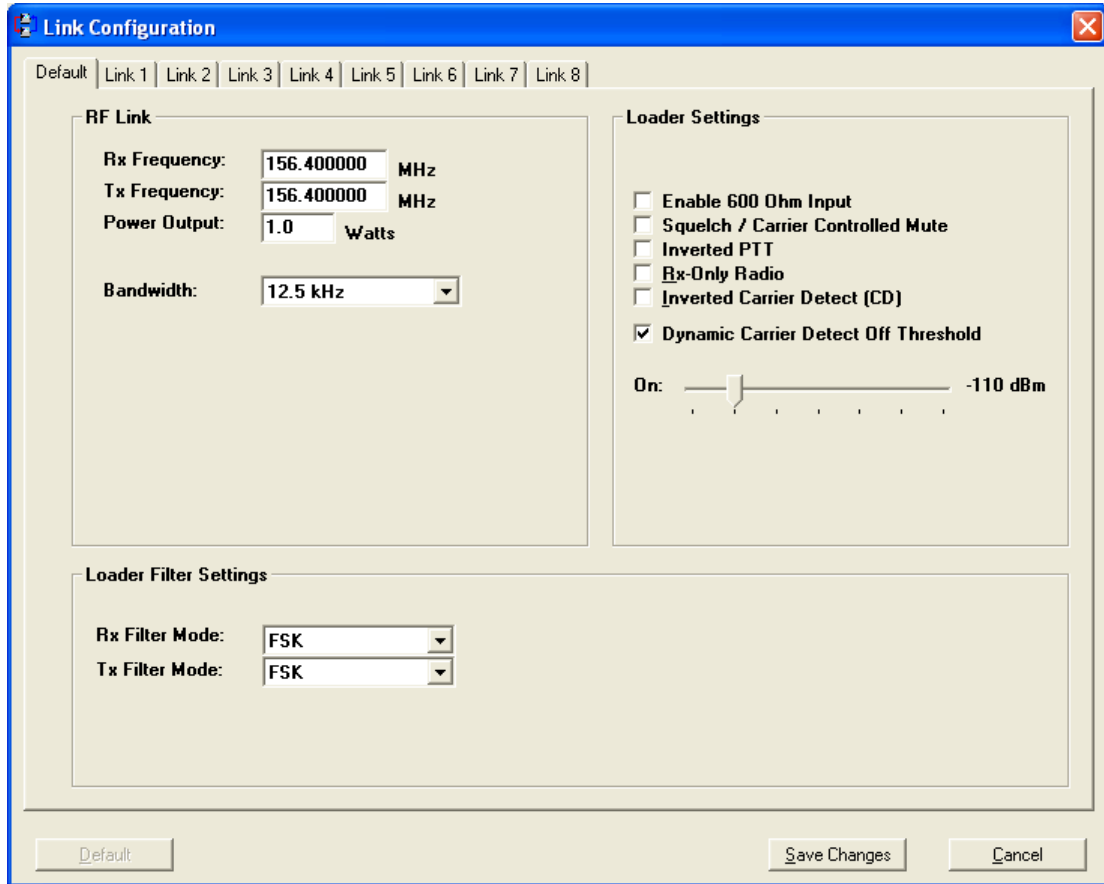

Default Link: This tab is used to set all the Guardian’s default settings. The default settings will be used in any of the 8 links where the Default check boxes are checked.

5.9.1 RF LINK

The RF Link panel contains settings for configuring the radio frequency (RF) link.

Rx Frequency

Receive frequency for the Guardian in MHz.

Tx Frequency

Transmit frequency for the Guardian in MHz.

Output Power

Output power of the Guardian’s RF link in Watts. Selectable in 1/10th watt increments up to 10 W max.

Bandwidth

Specifies the Bandwidth of the RF Link. Specifies whether the link is a Full Channel (25.0 kHz), Half Channel (12.5 kHz) or Quarter Channel (6.25 kHz).

5.9.2 LOADER SETTINGS

The Loader Settings are used to control various options available on the Guardian when configured in Loader Mode.

Enable 600 Ohm Input

Selects whether the Rx Audio input has a 600-ohm impedance. **The default value for this option is Disabled (Unchecked).**

Squelch / Carrier Controlled Mute

This option will mute the Guardian's audio output when there is no valid RF carrier signal. A valid RF carrier signal is determined by the Carrier Detect on setting that is programmed with the slider. **The default value is Disabled (Unchecked).**

Inverted PTT

Selects between Active High or Active Low input for PTT (Transmitting). If selected PTT signal is Active High. **Default value is Active Low (unchecked).**

Rx-Only Radio

The Rx Only Radio option disables the radio's transmitter and any ability for the Guardian to transmit.

Inverted Carrier Detect

Select for Active Low output for Carrier Detect (if programmed in User Port Configuration). **Default value is Active High (unchecked).**

Dynamic Carrier Detect OFF Threshold

Allows for the Modem to automatically adjust the Carrier Detect Off Threshold based on the RSSI while receiving data. If selected, the Carrier Detect Off level will automatically adjust to about 15 dB below the actual signal strength. This provides very fast detection of loss-of-carrier, which minimizes or eliminates "bit dribble" at the end of transmissions.

Recommendation: Leave this setting enabled (checked) unless interference or variable signal strength (such as fading in a moving vehicle) causes problems.

Carrier Detect On (Slider)

Adjust the slider to set the Carrier Detect on Threshold. This is the Receive Signal Strength Indicator (RSSI) level that the Guardian will recognize as a valid carrier signal. When the signal reaches the programmed threshold, the Guardian will begin decoding data.

5.9.3 LOADER FILTER SETTINGS

The Guardian Filter Settings allow the user to adjust the Rx and Tx Filter type.

FSK: Flat Response (100 - 3300 Hz).

Inverted FSK: Inverted Flat Response (100 - 3300 Hz).

Audio: Audio Response (300 - 3300 Hz). De-emphasis is applied.

Inverted Audio: Inverted Audio Response (300 - 3300 Hz). De-emphasis is applied.

Wide-AC: Wide Band AC-Coupled (20 - 10000 Hz). *See the FCC notice that follows.

Inverted Wide-AC: Inverted Wide Band AC-Coupled (20 - 10000 Hz). *See the FCC notice that follows.

Wide-DC: Wide Band DC-Coupled (0 - 10000 Hz). *See the FCC notice below.

***The wideband settings will invalidate the FCC type approval of this product!** The selected wideband mode will bypass the DL-3400 audio filtering. **To use the wideband setting, you must get your own FCC type approval for this product.**

5.10 USER PORT CONFIGURATION — LOADER MODE

The **User Port Configuration** button is in the **User Configuration** window near the bottom.

Figure 26 User Port Configuration Window – Loader Mode

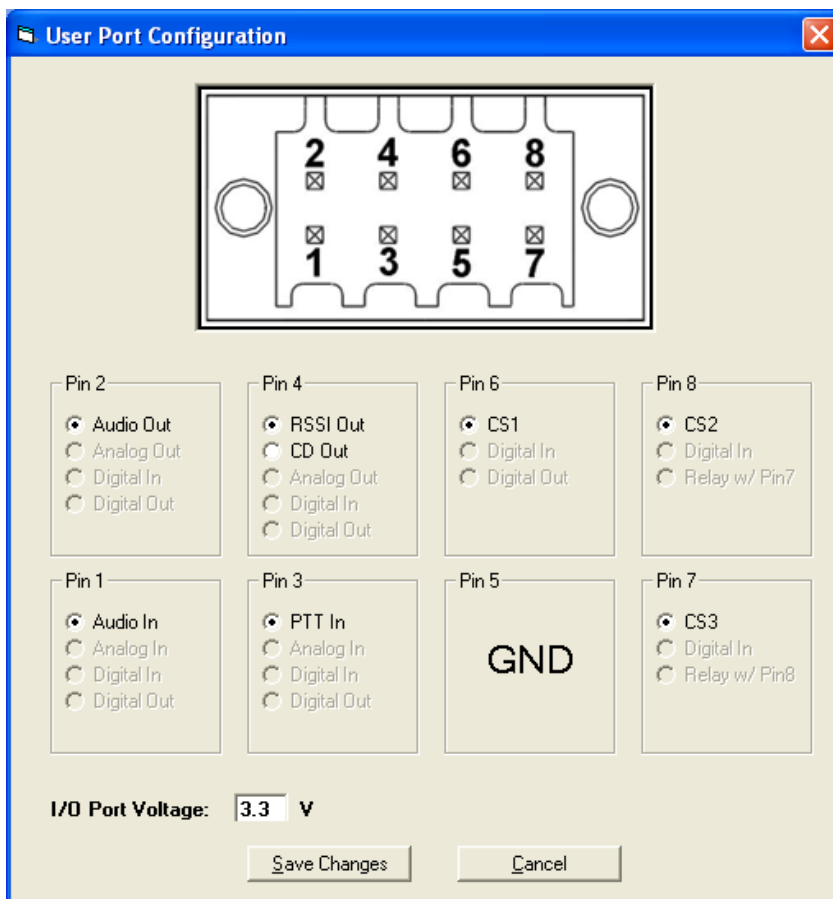

Audio Out: Pin will be programmed as an Audio Output. Modem audio will be output from the pin.

Analog In: Pin will be programmed as an Analog Input. Pin is connected to an analog to digital converter (ADC).

RSSI Out: Pin will be programmed as a Receive Signal Strength Indicator Output. A voltage representing the strength of the Guardian's received RF signal will be output from the pin.

CD Out: Pin will be programmed as a Carrier Detect Output. This pin will be asserted whenever the Carrier Detect conditions are met that were programmed in the Link Configuration window. The pin is normally Active High but can be made Active Low by checking the Inverted Carrier Detect check box on the Link Configuration window.

PTT In: Pin will be programmed as a Push to Talk (PTT) Input that will cause the Guardian to begin transmitting. PTT In is normally Active Low but can be changed to Active High by checking the Inverted PTT check box on the Link Configuration window.

CS1-3: Pin will be programmed as a Channel/Link Select. Any pins programmed as a Channel Select will be used as binary inputs to select the desired RF Link programmed in the Link Configuration window. Pins are internally pulled high.

I/O Port Voltage: Programs the input and output voltage of the pins on the Guardian User Port. Valid voltage range is from 3.3 - 5.0V. Default is 3.3V.

5.11 VERSION REQUEST

The **Version Request** window is accessed from the **Version** button in the Guardian Programmer window.

Selecting Version Request causes the Guardian Field Programming Software to display information about the version of the Guardian hardware and firmware.

Figure 27 Version Request

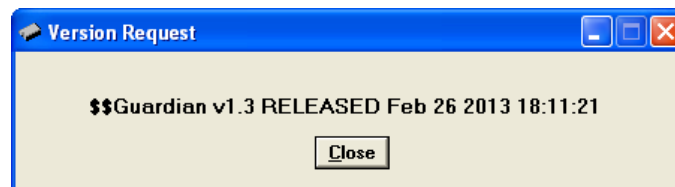

5.12 WRITING AND READING GUARDIAN CONFIGURATION PARAMETERS

After all radio parameters are set up in the **Link Configuration** window, click the **Save Changes** button to store the information into the PC's memory. Writing and reading Guardian Configuration parameters is accessed through the **User Configuration** window.

Figure 28 Read and Write buttons in the User Configuration Window

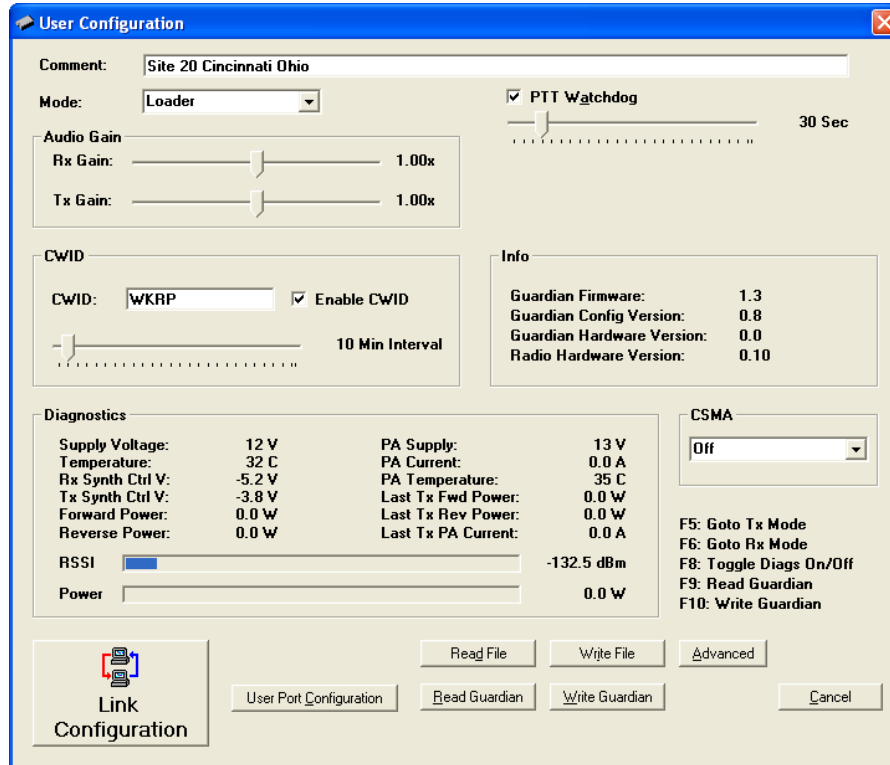

The **Read Guardian** button will read the configuration parameters from the current Guardian setup and store the information in local memory. The parameters can be viewed and/or edited with the User and Link Configuration windows.

The **Write Guardian** button will write the configuration parameters from the current User Configuration window to the Guardian Modem and store the information in non-volatile memory. The Guardian will immediately begin using the new configuration.

The **Read File** and **Write File** buttons are used to read or write a User Configuration to or from a file on a PC. This can be useful for saving different Guardian configurations so they can be easily written into multiple Guardian Modems.

Note: NextGen RF recommends a Read be done anytime an initial connection is made to the Guardian Setup Port before accessing the Link Configuration window. This will help avoid writing erroneous parameters to the connected unit. A "Read Guardian" is automatically performed when the User Configuration window is opened with a Guardian Modem connected.

5.13 DIAGNOSTIC IDS, ALARMS AND FILTERS

The **Diagnostic IDs, Alarms and Filters** window is accessed from the Utilities menu.

The Diagnostics IDs and Alarms window allows the user to set up the ID List for use with the Offline Link Test and Offline and Online Diagnostics as well as the Alarms for use with Online Diagnostics.

Figure 29 Diagnostic IDx, Alarms, and Filters Window

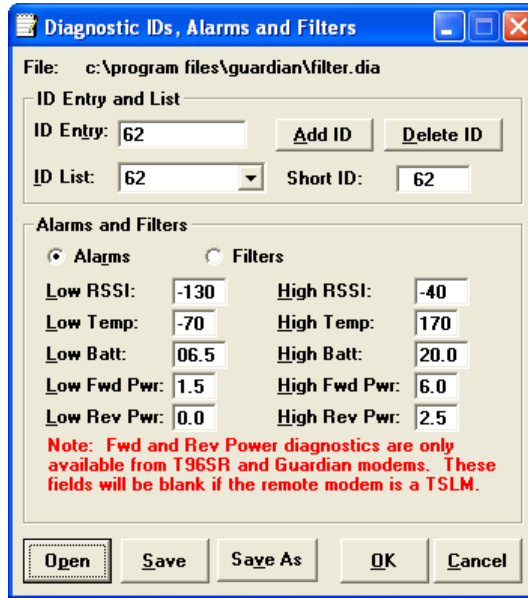

ID Entry and List

Allows the entry of a Long ID to be added to the ID List. The range of this field is 1 to 4294967295 but multiples of 1024 should not be used. A multiple of 1024 results in a Short ID of 0. If the Long ID is within the range of 1 to 1023, the Short ID will be the same or the resulting Short ID will be smaller than the Long ID and will be represented by a “+” character in front of the ID. A Long ID is added to the ID List by an “Enter” or by clicking the Add ID button.

ID List: Allows the user to select a Long ID from the list to delete. A Long ID is deleted from the list by clicking the Delete ID button.

Short ID: Shows the converted Short ID from the selected Long ID of the ID List.

Alarms and Filters

Alarms and Filters are used with Online Diagnostics. When Online Diagnostics are received and a diagnostic field falls outside the Alarm limits, a “<” character will designate a value less than the low Alarm and a “>” character will designate a value greater than the High Alarm.

When Online Diagnostics are received and a diagnostic field falls outside the Filter Limits, the diagnostic information is considered invalid and is not displayed.

Low/High RSSI: Represents the low and high limits for the RSSI diagnostics (in dBm).

Low/High Temp: Represents the low and high limits for the temperature diagnostics (in degrees C).

Low/High Batt: Represents the low and high limits for the battery voltage diagnostics (in volts).

Low/High Fwd. Pwr: Represents the low and high limits for the forward power diagnostics (in watts).

Low/High Rev Pwr: Represents the low and high limits for the Reverse Power diagnostics (in watts).

Open

The Open button allows the user to restore Diagnostics IDs, Alarms and Filters from a previously saved file.

Save

The Save button allows the user to save the current Diagnostics IDs, Alarms and Filters to the current file.

Save As

The Save As button allows the user to save the current Diagnostics IDs, Alarms and Filters to a name different than the current file.

5.14 OFFLINE LINK TEST

The **Offline Link Test** window is accessed from the **Utilities** menu.

The Offline Link Test is used to test the link between two units: the local unit interfaced to the computer and a remote unit. Blocks of data are transmitted to the remote unit and the remote unit decodes and returns them. The transmitted and received blocks of data are compared and ratios of the results are calculated.

Note: An Offline Link Test requires suspension of user network operation.

Figure 30 Offline Link Test Window

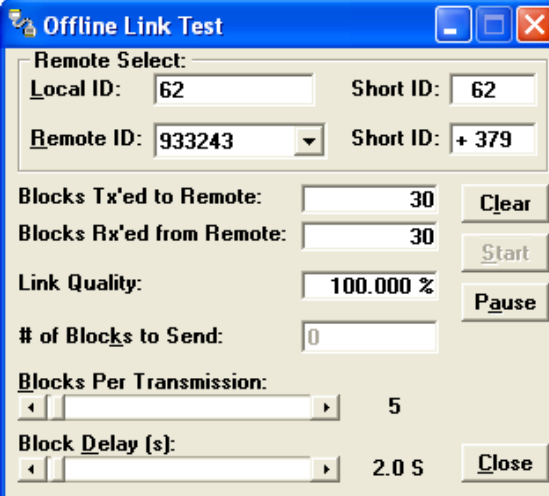

The screenshot shows the 'Offline Link Test' window with the following fields and values:

Remote Select:	
Local ID:	62
Short ID:	62
Remote ID:	933243
Short ID:	+ 379
Blocks Tx'ed to Remote:	30
Blocks Rx'ed from Remote:	30
Link Quality:	100.000 %
# of Blocks to Send:	0
Blocks Per Transmission:	5
Block Delay (s):	2.0 S

Buttons: Clear, Start, Pause, Close

Remote Select

Local ID: The Long ID of the unit connected to the computer. The Short ID is displayed.

Remote ID: Allows selection of the unit (by choosing its Remote ID) from which the Link Test information is gathered. Remote IDs are set up in the Diagnostics IDs, Alarms and Filters window. The Short ID is displayed. An Offline Link Test returns the following statistics:

Blocks Tx'ed to Remote

Displays the number of data blocks transmitted to the remote unit.

Blocks Rx'ed from Remote

Displays the number of data blocks received from the remote unit.

Link Quality

Displays the ratio of data blocks received to data blocks transmitted (in %).

of Blocks to Send

Allows the user to determine the number of blocks to send before stopping (with 0 being disabled).

Blocks Per Transmission

Allows the selection of the number of blocks per transmission (1 to 200 blocks).

Block Delay (s)

Allows the user to determine the delay between transmission of data blocks in 0.05 second intervals (0.00 to 120.00 seconds).

Clear

Allows the user to clear the display (blocks transmitted, blocks received and link quality).

Start

Used to begin the test.

Pause

Used to pause the test and allows the user to resume the test later.

5.15 OFFLINE DIAGNOSTICS

The **Offline Diagnostics** window is accessed from the **Utilities** menu.

Offline Diagnostics are returned from a local or remote unit in response to a Get Diags/Stats request (see the following figure).

Note: An Offline Diagnostics request requires suspension of user network operation.

Figure 31 Offline Diagnostics Window

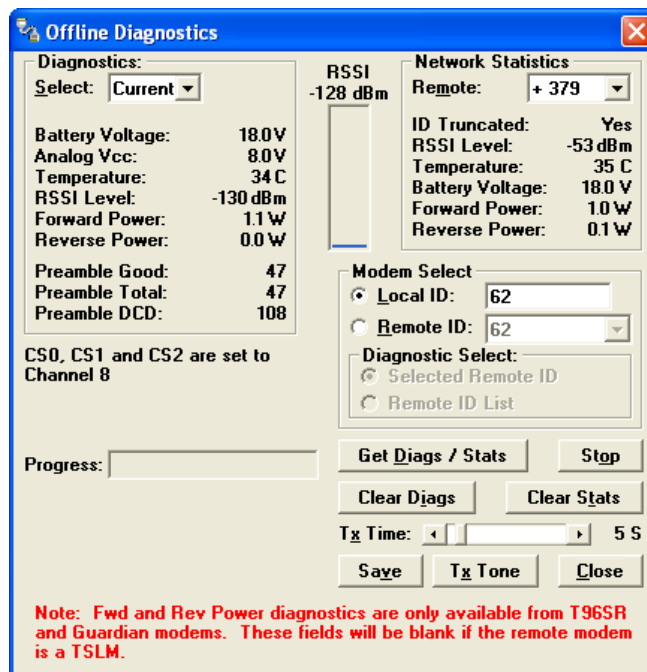

Diagnostics

Select

Allows the user to choose Current, Low or High Diagnostics. Current shows the value of the last requested parameters. Low or High displays the lowest or highest value of the parameters since the last Clear was performed or the last time power was removed.

Offline Diagnostics parameters include the following:

- **Battery Voltage:** supply voltage.
- **Analog V_{CC}:** Analog Circuits Regulated Supply (the 5V supply of legacy products or the transmit voltage).
- **Temperature:** internal case temperature (in Celsius).
- **RSSI Level:** Received Signal Strength Indication (in dBm).
- **Forward Power:** Forward Power (in watts).
- **Reverse Power:** Reverse Power (in watts).
- **Preamble Good:** the number of correctly decoded transmissions received in the last 15. Used with Preamble Total, this serves as an indication of how well the unit is receiving data.
- **Preamble Total:** the number of total transmissions detected; maximum is 15. Used with Preamble Good, this serves as an indication of how well the unit is receiving data.
- **Preamble DCD:** this number shows a count of all received Carrier Detects.

RSSI Panel

Shows the current RSSI level (in dBm) while the local unit is receiving.

Network Statistics

Offline Network Statistics are only available when the Online Diagnostics option is enabled for the network. Online Diagnostics are in the Setup Modem/Radio Parameters window. When enabled, diagnostic information is inserted at the beginning of each transmission from each unit in the network.

Network Statistics include:

- **Remote:** Remote drop-down allows the user to select from the remote list which network statistics to display.
- **ID Truncated:** Shows the user the Long and Short ID are not the same.
- **RSSI Level:** Shows the current RSSI level (in dBm) while the Local unit is receiving.
- **Temperature:** Shows the internal case temperature (in Celsius).
- **Battery Voltage:** Shows the supply voltage (in Volts).
- **Forward Power:** Shows forward power (in Watts).
- **Reverse Power:** Shows reverse power (in Watts).

Modem Select

Local ID: The Local ID button allows the user to send commands to the local unit (the unit interfaced to the computer).

Remote ID: The Remote ID button allows the user to send diagnostic commands to any specific remote unit and obtain its diagnostic information. The Remote ID is selected from the list of Remote IDs set up in the Diagnostics IDs, Alarms and Filters window.

Diagnostic Select

Selected Remote ID: This button allows the user to gather Offline Diagnostics from the selected Remote ID only.

Remote ID List: This button allows the user to gather Offline Diagnostics from all the IDs in the list of Remote IDs (including the local unit).

Progress: Displays the progress of obtaining Remote Diagnostics.

Tx Tone

The Tx Tone button will send a remote or local command to cause the Guardian to transmit a tone. This can be used to create network traffic so that offline diagnostics of remotes can be monitored.

Get Diags/Stats: The Get Diags/Stats button allows the user to send the command for Offline Diagnostics. The command is sent to the unit connected to the computer if the Local ID button is selected. The command is sent to the selected Remote ID if the Remote ID and Selected Remote ID buttons are selected. The command is sent to the list of Remote IDs if the Remote ID and Remote ID List buttons are selected.

Stop: Allows the user to stop any commands for Offline Diagnostics from being sent.

Clear Diags: Clears the unit diagnostics.

Clear Stats: Clears the unit network statistics.

Save: Allows the user to save the current Offline Diagnostics to a file.

Close: Closes the Offline Diagnostics window.

5.16 ONLINE DIAGNOSTICS

The **Online Diagnostics** window is accessed from the **Utilities** menu.

Online Diagnostics are transmitted by each unit in a network before the user's data is transmitted. All units must be programmed with the Online Diagnostics parameter to receive Diagnostics from a system. The unit that the computer is interfaced with will output Online Diagnostics as they are received. This unit must have the Output Online Diagnostic Data to the Setup Port parameter programmed (found on the Setup Modem/Radio Parameters window).

Note: Using Online Diagnostics does not require suspension of network operation.

Online Diagnostics are subject to alarm and filter conditions defined in the Diagnostic IDs, Alarms and Filters window (see the following figure). When Online Diagnostics are received and a diagnostic field falls outside the alarm limits, a "<" character will designate a value less than the low alarm and a ">" character will designate a value greater than the high alarm. If Online Diagnostics are received and a diagnostic field falls outside the filter limits, the diagnostic information will be considered invalid and will not be displayed.

Figure 32 Online Diagnostics

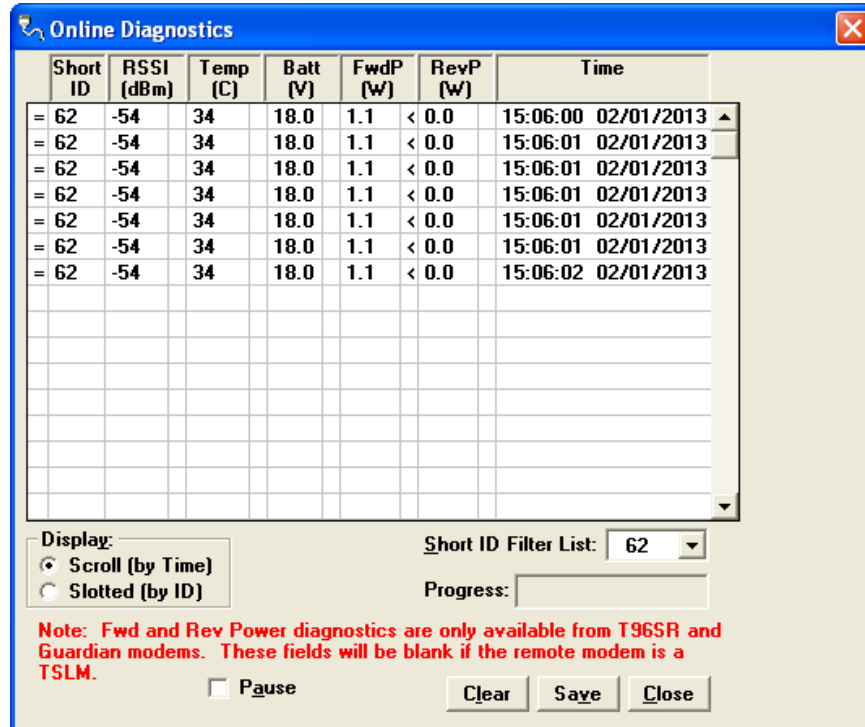

The following online diagnostics are gathered and displayed in the Online Diagnostics window.

Short ID: Displays the Short ID of the unit transmitting the diagnostics.

RSSI: RSSI (Received Signal Strength Indicator) displays the RSSI (in dBm) of the unit transmitting the diagnostics. This is the RSSI sampled during the last transmission received.

Temp: Displays the internal case temperature (in Celsius) of the unit transmitting the diagnostics.

Batt: Displays the supply voltage (in volts) of the unit transmitting the diagnostics.

FwdP: Displays the forward power (in watts) of the unit transmitting the diagnostics.

RevP: Displays the reverse (reflected) power (in watts) of the unit transmitting the diagnostics.

Time: Displays the time stamp when the diagnostics were received.

Filter: Allows the user to filter Short IDs. The following options are available:

- **Off (All IDs):** No IDs are filtered out.
- **ID List:** Only the IDs in the Filter ID List are shown.
- **Selected ID:** Only the selected ID in the Filter ID List is shown.

Display: Allows the user to choose how data is displayed in the window. The following options are available:

- **Scroll (by time):** Displays the diagnostics as they are received.
- **Slotted (by ID):** Sorts the diagnostics by Short ID. Using this option, each Short ID will have one row of diagnostics, showing the most recent information.

Short ID Filter List: A listing of Remote IDs setup in the Diagnostics IDs, Alarms and Filters window. This list is used for selecting a filter.

Progress: The Progress panel shows the sorting progress of the diagnostics if a filter was changed.

Pause: The Pause check box allows the user to pause the reception of the diagnostics for scrolling through the grid.

Clear: The Clear button allows the user to clear the display and current Online Diagnostics.

Save: The Save button allows the user to save the current Online Diagnostics to a file. A maximum of 4096 lines of data can be saved.

5.17 PACKET TEST

The **Packet Test** window is accessed from the **Utilities** menu.

Figure 33 Packet Test Window

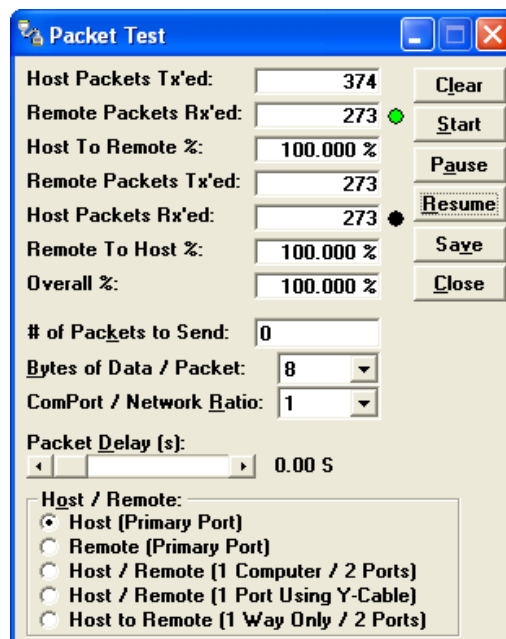

The Packet Test window is used to simulate a Host/Remote polling environment. The Master unit will send out a packet to the Remote and the Remote will reply to the Master with the same packet information. This is a useful utility for testing modem communication.

Host Packets Tx'ed: Shows the number of data packets the Master has sent to the Remote.

Remote Packets Rx'ed: Shows the number of data packets the Remote device has received from the Master.

Host to Remote %: Shows the percentage of packets the Host device has successfully sent to the Remote.

Remote Packets Tx'ed: Shows the number of data packets that the Remote device has returned to the Host.

Host Packets Rx'ed: Shows the number of data packets the Host device has received from the Remote.

Remote to Host %: Shows the number of packets the Remote device successfully sent to the Host.

Overall %: Shows the percentage of Host received packets versus Host transmitted packets.

of Packets to Send: Programs the number of packets the Host should send to the Remote before stopping.

Bytes of Data / Packet: The programmable number of data bytes in each packet the Host sends. The Remote will respond with the same number of packets.

COM Port/Network Ratio: The ratio of the COM port baud rate to network (over the air) baud rate of a modem. This is used if the network baud rate is slower than the COM port baud rate. If the COM port baud rate is 9600 and the network baud rate is 4800, set the ratio to 2. If the two are the same, set this field to 1.

Packet Delay(s): The number of seconds for the Host to delay between sending each packet. This field ranges from 0.00 to 10.00 seconds (in 0.25 second intervals).

Host/Remote: This is used to configure COM port options.

- **Host (Primary Port):** Configures the primary COM port as the Host device (the device initiating packets to the Remote device).
 - **Remote (Primary Port):** Configures the primary COM port as the Remote device (the device responding to the packets from the Host device).
 - **Host/Remote (1 computer / 2 ports):** Configures the primary COM port as the Host device and the secondary COM port as the Remote device. This option requires a computer with 2 COM ports.
- Host/Remote (1 Port using a Y-cable):** Configures the primary COM port as the Host and Remote device.

A Y-cable is required for this option (with transmit connections split to the transmitting device and receive connections split to the receiving device). A computer with 1 COM port is utilized for this option.

Table 16 Y-Cable Connections

Pin Name	DE-9	DB-25	Computer	Rx	Tx
DCD	1	8	X	X	–
RxD	2	3	X	X	–
TxD	3	2	X	–	X
DTR	4	20	–	–	–
GND	5	7	X	X	X
DSR	6	6	–	–	–
RTS	7	4	X	–	X
CTS	8	5	X	–	X
RI 9	9	2	–	–	–

X = Requires Connection
– = No Connection

5.18 ARRAY TEST

The **Array Test** window is accessed from the **Utilities** menu. The Array Test is used to send programmable length test packets. See Table 16 above for Y-Cable Connections.

Figure 34 Array Test Window

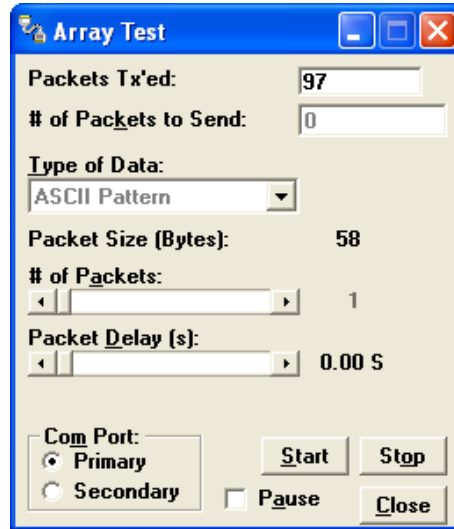

Packets Tx'd: Total number of packets transmitted.

of Packets to Send: Allows the user to set the total number of packets to send before stopping. (Field range is 0 to unlimited.)

Type of Data: Type of Data allows the user to select the data pattern for each packet. The size for each data pattern is listed in the pattern format explanations. (Packets are built using one of four possible patterns.)

- **ASCII Pattern:** Packets are 58 characters in length and have a sequence number at the beginning of each string starting with 000, incrementing to 999 then wrapping around to 000 again.

The pattern used to build the packets will have the following format (in ASCII):

```
000 ABCDEFGHIJKLMNOPQRSTUVWXYZabcdefghijklmnopqrstuvwxyz
001 ABCDEFGHIJKLMNOPQRSTUVWXYZabcdefghijklmnopqrstuvwxyz
---
998 ABCDEFGHIJKLMNOPQRSTUVWXYZabcdefghijklmnopqrstuvwxyz
999 ABCDEFGHIJKLMNOPQRSTUVWXYZabcdefghijklmnopqrstuvwxyz
000 ABCDEFGHIJKLMNOPQRSTUVWXYZabcdefghijklmnopqrstuvwxyz
001 ABCDEFGHIJKLMNOPQRSTUVWXYZabcdefghijklmnopqrstuvwxyz
---
```

- **ASCII Number Pattern:** The packets will be 51 characters in length and have a sequence number at the beginning of each string, starting at 000 and incrementing to 999, then wrapping around to 000 again.

The pattern used to build the packets will have the following format (in ASCII):

```
000 00 11 22 33 44 55 66 77 88 99 AA BB CC DD EE FF
001 00 11 22 33 44 55 66 77 88 99 AA BB CC DD EE FF
---
998 00 11 22 33 44 55 66 77 88 99 AA BB CC DD EE FF
999 00 11 22 33 44 55 66 77 88 99 AA BB CC DD EE FF
000 00 11 22 33 44 55 66 77 88 99 AA BB CC DD EE FF
001 00 11 22 33 44 55 66 77 88 99 AA BB CC DD EE FF
---
```

- **Binary Pattern:** The packets will be 16 characters in length and have a sequence number every 16 characters, starting at 0x00 and incrementing to 0xFF, then wrapping around to 0x00 again.

The pattern used to build the packets will have the following format (in Hex):

```
00 11 22 33 44 55 66 77 88 99 AA BB CC DD EE FF
01 11 22 33 44 55 66 77 88 99 AA BB CC DD EE FF
02 11 22 33 44 55 66 77 88 99 AA BB CC DD EE FF
-- 11 22 33 44 55 66 77 88 99 AA BB CC DD EE FF
FE 11 22 33 44 55 66 77 88 99 AA BB CC DD EE FF
FF 11 22 33 44 55 66 77 88 99 AA BB CC DD EE FF
00 11 22 33 44 55 66 77 88 99 AA BB CC DD EE FF
01 11 22 33 44 55 66 77 88 99 AA BB CC DD EE FF
02 11 22 33 44 55 66 77 88 99 AA BB CC DD EE FF
-- 11 22 33 44 55 66 77 88 99 AA BB CC DD EE FF
```

- **Random Binary Pattern:** The packets will be 16 characters in length and contain random binary data.

of Packets: # of Packets allows the user to set the number of packets in each transmission.

Packet Delay: Packet Delay allows the user to set the amount of time (in seconds) to delay between each packet transmission, ranging from 0.00 to 30.00 seconds (in 0.25 second intervals).

Com Port: Com Port allows the user to select the COM port (primary or secondary) for data transmission.

5.19 ASCII / HEX TERMINAL

The **ASCII/HEX Terminal** windows are accessed from the **Utilities** menu.

Terminal windows allow the user to select an ASCII or Hexadecimal Terminal window for the Primary and Secondary COM Ports (configured in the window — see Section 5.3) Data is sent according to the port configuration set up in the Port Settings window.

ASCII / HEX Terminal windows allow the user to select an ASCII or Hexadecimal Terminal window for the Primary and Secondary COM Ports (configured in the Port Settings window) Data is sent according to the port configuration set up in the Port Settings window.

5.19.1 ASCII TERMINAL

ASCII Terminal configurations include Primary and Secondary.

Primary: The Primary ASCII Terminal window sends and receives ASCII data on the Primary COM Port (set up in the Port Settings window).

Secondary: The Secondary ASCII Terminal window sends and receives ASCII data on the Secondary COM Port (set up in the Port Settings window).

5.19.2 HEX TERMINAL

Hex Terminal configurations include Primary and Secondary.

Primary: The Primary Hex Terminal window selects a Hexadecimal Terminal window to send and receive Hexadecimal data on the Primary COM Port (set up in the Port Settings window).

Secondary: The Secondary Hex Terminal window selects a Hexadecimal Terminal window to send and receive Hexadecimal data on the Secondary COM Port (set up in the Port Settings window).

5.20 GUARDIAN FIRMWARE AND CONFIGURATION

The Program File Upload/Download window is accessed from the Utilities menu.

Figure 35 Guardian File Upload / Download Window

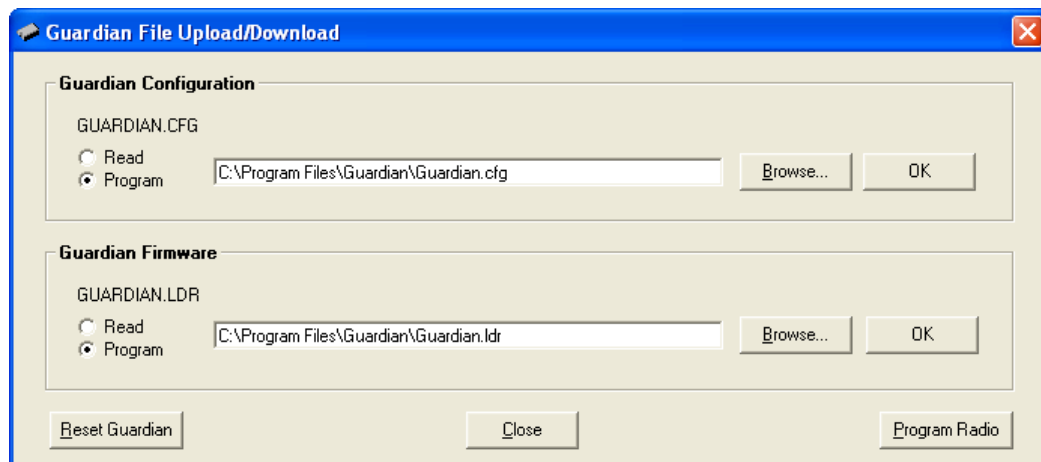

The Guardian File Upload/Download window allows the user to read or program the Guardian firmware (GUARDIAN.LDR) or read or program the Guardian's User Configuration File (GUARDIAN.CFG). The Guardian Configuration file contains all of the user-programmable parameters for the Guardian. The Guardian Firmware file contains the operating software that controls the Guardian Modem.

The Guardian Configuration section is used to read or program a configuration file (*.CFG) to or from a Guardian Modem. This is useful for programming a previously saved configuration file (see section 5.12) into the Guardian Modem or to replicate a configuration across a number of Guardian Modems.

To read the configuration file from a Guardian Modem

1. Select the Read option in the Guardian Configuration section.
2. Click the Browse button to select the path and filename of the location to save the configuration file.
3. Click OK to start the read. A message will be displayed when the file has been read and saved to the PC.

To program a configuration file into a Guardian Modem

Caution: To avoid corrupting configuration settings, the Guardian should be taken offline from PLC control and the antenna disconnected before programming configuration information.

1. Select the Program option in the Guardian Configuration section.
2. Click the Browse button to select the configuration file to be programmed.
3. Click OK to start the programming process. A file transfer progress window will be displayed, and a message will be displayed when the file has been successfully programmed into the Guardian.

To program a new firmware file into a Guardian Modem

Caution: To avoid corrupting the firmware, the Guardian should be taken offline from PLC control and the antenna disconnected before programming the firmware.

1. Select the Program option in the Guardian Firmware section.
2. Click Browse to select the Guardian Firmware to be programmed.
3. Click OK to start the programming process. A file transfer progress window will be displayed, and a message will be displayed when the firmware file has been successfully programmed into the Guardian. The Guardian will reset automatically and begin running the programmed firmware.

5.21 END TO END TEST

The Field Programming Software has several useful utilities embedded in the program that assist in testing the wireless modems. The testing setup requires a computer running the Field Programming Software attached to each user COM port on the Guardian wireless modems. The Utilities will allow the user to send ASCII text or Hex characters through the Guardians being tested.

The Guardian modems must be set up so that they have the appropriate receive and transmit signal levels for the test. The signal strength will be much stronger if the units are tested on the bench compared to being tested in a field installation. These signals must be attenuated, or the output power level adjusted if the units are being tested on the bench.

ASCII Terminal

Under the Utilities menu choose the ASCII Terminal. From the ASCII Terminal window, choose the Primary selection. This will open an ASCII terminal window using the primary COM port of the computer. This procedure should be performed for both Guardian modems.

The ASCII Terminal utility has provisions for transmitting the ASCII data, displaying received ASCII data and displaying ASCII transmitted data. Figure 36 shows the window for the Primary and Secondary ASCII Terminals.

Figure 36 End-to-End Test using ASCII Terminal

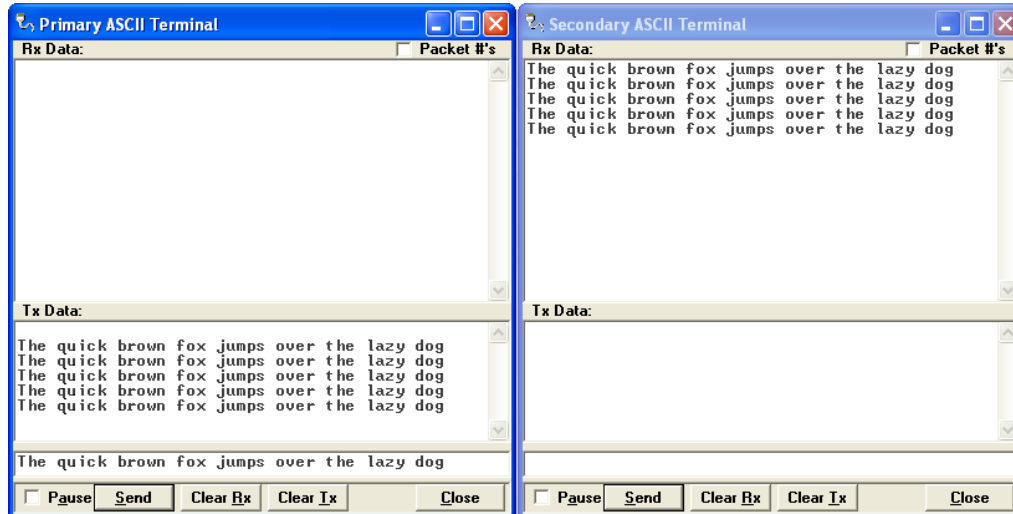

The above figure also shows the area that is used to send an ASCII text message. The ASCII data message is typed into this area. The ASCII text message is then sent out the first Guardian through the computer's primary port once the Send button is clicked. The sent ASCII message is then displayed in the Tx Data area of the ASCII Terminal window. The ASCII message is transmitted to the other Guardian. The ASCII terminal program will display the received ASCII message in the Rx Data area.

If the message was not displayed as typed, then a problem may exist in the system. Check all parameters and connections in the system. The signal level should also be checked again. The Guardian's Link Test utility can be used to verify a communication path.

Hex Terminal

Under the **Utilities** menu choose the **Hex Terminal**. From the Hex Terminal window, choose the **Primary** selection.

The previous procedure can also be used with the Hex Terminal utility. When the Hex Terminal is used, the information is entered as hex code. Figure 37 shows how the information will look when it is typed in and sent in hex. In the Hex Terminal mode, the program will not transmit ASCII information. It will only allow valid hex characters.

Figure 37 End-to-End Test using Hex Terminal

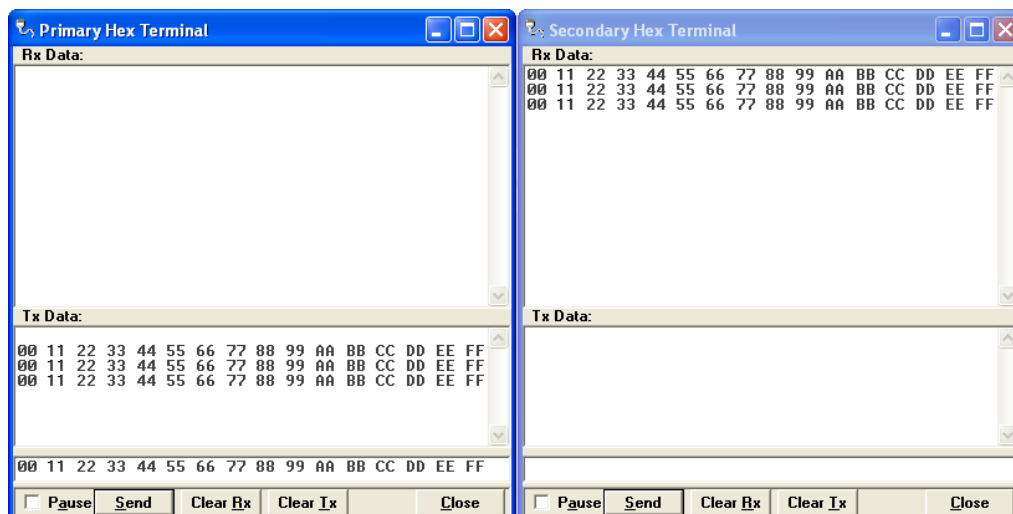

Guardian Specifications

These specifications are typical and subject to change without notice.

General		VHF	UHF	900
Model Numbers		140-5015-50x 140-5026-50x	140-5046-30x 140-5046-50x	140-5096-50x
Frequency Range (MHz)		136 – 174 MHz 215 – 240 MHz	406.125 – 470.000 MHz 450.000 – 511.975 MHz	928 – 960 MHz
Frequency Stability		1.0 ppm	1.0 ppm	1.0 ppm
Channel Bandwidth		12.5 kHz 25 kHz	12.5 kHz 25 kHz	12.5 kHz 25 kHz
Modes of Operation		Simplex, Half-Duplex, Duplex		
Frequency Increment		1.25 kHz		
Power Source		10 – 30 VDC, Negative GND The Guardian is UL approved when powered with a listed Class 2 power supply.		
RF Impedance		50 Ω		
Operating Temperature		- 30° to + 60° C		
Storage Temperature		- 40° to + 85° C, 95% non-condensing RH		
Operating Humidity		5% to 95% non-condensing RH		
Rx Current Drain at 25° C		DC Input 10 V	DC Input 20 V	DC Input 30 V
		520 mA (max.) 450 mA (typ.)	270 mA (max.) 240 mA (typ.)	190 mA (max.) 170 mA (typ.)
Tx Current Drain at 25° C	Power Out	DC Input 10 V	DC Input 20 V	DC Input 30 V
	Max. Power	5.8 A (max.) 3.6 A (typ.)	2.5 A (max.) 1.8 A (typ.)	1.6 A (max.) 1.2 A (typ.)
	30 dBm (1 W)	1.6 A (max.) 1.2 A (typ.)	0.8 A (max.) 0.6 A (typ.)	0.6 A (max.) 0.4 A (typ.)
Cold start		500 milliseconds		
Nominal Dimensions		5.50 in. W × 2.125 in. H × 4.25 in. D (13.97 × 5.40 × 10.8 cm)		
Shipping Weight		2.4 lbs. (1.1 Kg)		
Mounting Options		Mounting plate/pattern and DIN Rail		
Fan Output		5 VDC, 400 mA max.		

Transmitter	VHF	UHF	900
Tx Frequencies	136 – 174 MHz 215 – 240 MHz	406.125 – 470.000 MHz 450.000 – 511.975 MHz	928 – 960 MHz
Carrier Output Power	1-10 Watts Adjustable	1-10 Watts Adjustable	1-8 Watts Adjustable
Duty Cycle	100% (Power Foldback Allowed for High Temperatures)		
Radiated Spurious Emissions	Per FCC Regulatory		
Conducted Spurious Emissions	Per FCC Regulatory		
Transmitter Stability into VSWR	> 10:1 (Power Foldback Allowed)		
Rx to Tx Time	< 2 ms (Standard)		

Transmitter		VHF		UHF		900
Channel Switching Time		< 15 ms (Band-End to Band-End)				
Receiver						
	Bandwidth Bit Rate	140-5016- 50x	140-5026- 50x	140-5046-30x 140-5046-50x	140-5096- 50x	Units
Rx Frequencies		136 - 174	215 - 240	406.125 – 470.000 450.000 – 511.975	928 - 960	MHz
Data Sensitivity @ 10 ⁻⁶ Bit Error Rate (BER)	12.5 kHz 4.8 kbps 9.6 kbps	-110 -107	-110 -107	-110 -107	-110 -107	dBm
Typical / Max.	25 kHz 4.8 kbps 9.6 kbps 19.2 kbps	-110 -107 -100	-110 -107 -100	-110 -107 -100	-110 -107 -100	dBm
Adjacent Channel Rejection (min.)	12.5 kHz	60	60	60	60	dB
	25 kHz	75	70	75	70	dB
Spurious Response Rejection	All	> 75 dB				dB
Inter-modulation Rejection	All	> 75 dB				dB
Tx to Rx Time	All	< 1 ms (Standard) 5 ms (ETSI Versions)				ms
Channel Switching Time	All	< 15 ms (Band-End to Band-End)				ms
Receive Input Power	All	17 dBm (50 mW) max.				dBm

Modem / Logic	Model	12.5 kHz	25 kHz
Data Rate (Selectable)	140-5016-50x	4800 9600	4800 9600 19200
	140-5026-50x	4800 9600	4800 9600 19200
	140-5046-30x	4800 9600	4800 9600 19200
	140-5046-50x	4800 9600	4800 9600 19200
	140-5096-50x	4800 9600	4800 9600 19200
Modulation Type	2FSK		

Modem / Logic			
Addressing	Serial		

SETUP and COM Port	
Interface	EIA-232F DCE
Data Rate	Setup Port: 57,600 bps COM Port: 110 – 57,600 bps (Default: 9.6 Kbps)

Display	
5 Tri-color status LEDs	Power, Status, Rx, Tx, RD/TD

Connectors	
Antenna Connector	TNC Female (Tx/Rx), SMA Female (Rx) – Dual-Port and Full-Duplex models only
Serial Setup Port	DE-9F
Serial COM Port	DE-9F
User Interface	I/O Right angle, 8 contacts (male)
Power – I/O	I/O Right angle, 4 contacts (male) Power Plug

Diagnostics	
Message Elements	Temp, Voltage, Local/Remote RSSI, Forward Power, Reverse Power, Message Quality

APPENDIX A — ABBREVIATIONS AND DEFINITIONS

CD: Carrier Detect

CSMA: Carrier Sense Multiple Access

CTS: Clear to Send

CWID: a station identifier or “call sign” broadcast in Morse code at specified periodic intervals to identify the broadcasting radio

DCD: Data Carrier Detect

DOX: Data Operated Transmit

DSR: Data Set Ready

DTR: Data Terminal Ready

EIRP: Effective Isotropic Radio Power

FCC: Federal Communications Commission (United States)

FPS: Field Programming Software

FSK: Frequency-Shift Keying, an electronic communications modulation scheme

IC: Industry Canada

PA: Power Amplifier

PCB: Printed Circuit Board

PTT: Push to Talk

RF: Radio Frequency

RS-232, RS-422, RS-485: Standard Serial communication protocols

RSSI: Received Signal Strength Indication

RTS: Request to Send

Rx: Receive

SMA: Subminiature version A (connector)

TNC connector: Threaded Neill-Councilmen connector

Tx: Transmit

VDC: Voltage, Direct Current

APPENDIX B — GUARDIAN AND DL-3400 INTEROPERABILITY

This appendix provides information for the implementation of the Guardian serial radio modem into an existing DL-3400 analog system.

Figure 38 Guardian Serial Radio Modem and DL-3400



APPLICABLE PRODUCTS

DL-3400 Analog Transceiver and Guardian X00 Wireless Modem.

APPLICATION

The DL-3400 is an analog transceiver that can operate in the VHF, UHF, and 900 MHz frequency bands depending on the part number ordered. The radio can operate at 25 kHz bandwidth or 12.5 kHz also depending on the part number ordered.

The Guardian serial radio modem can operate at VHF, 200 MHz, UHF, and 900 MHz frequencies. The radio will operate at 25 kHz of bandwidth or 12.5 kHz of bandwidth. The user can select the operating mode by using the Guardian FPS (Field Programming Software) and selecting the proper bandwidth. Reference [Part Numbers and Availability](#) and the Guardian Field Programming Software chapter in this User Manual for additional information about Guardian frequency ranges and bandwidth selection.

The Guardian and DL-3400 are OTA (over-the-air) compatible. A Guardian will be configured through the FPS to match the parameters of the existing DL-3400 system.

HARDWARE

Although the Guardian and DL-3400 are OTA compatible, there are physical differences between the two product lines.

- Antenna connector
 - o DL-3400 – Female SMA connector
 - o Guardian – Female TNC connector
 - o See Table 10 for a list of Coaxial Adapter Cables that are available for use with the Guardian.
- Power connection
 - o DL-3400 uses a red and black wire from the 10-pin interface cable.
 - Power input 10-15 VDC at 3 A maximum.

- Guardian uses a 4-pin power connector.
 - Uses a 3-wire connection. The “white” wire must be connected to B+
 - Power cable is included with the Guardian.
 - Power cable PN 897-5008-010
 - Power input: 10-30 VDC at 60 watts maximum.
- Interface connections
 - DL-3400 uses a 10-pin ribbon cable connector
 - DL-3400 user interface cable adapts from a 10-pin ribbon connection to spade-lug terminations, PN 023-3410-109
 - Guardian uses an 8-pin User Interface Port connector
 - Connector is included with the Guardian
 - Connector is PN 415-1001-208
 - Wires (28 AWG minimum, 18 AWG maximum) can be inserted into the connector block using a 2.5 mm Insertion Tool (NextGen RF PN 250-5006-001) or by using a small screwdriver
- Mechanical footprint
 - The DL-3400 and the Guardian do not have the same mechanical footprint.
 - Reference Chassis Dimensions, earlier in this user manual, which shows the mechanical layout of the Guardian.
 - See page 7 section 1.4.7 Figure 5 for Chassis Dimensions.
- Programming
 - The Guardian uses programming software unique to the Guardian.
 - The Guardian programming cable is simply a standard DE-9 to DE-9 straight-through serial cable and no longer requires unique cabling.
 - Programming cable is NextGen RF PN 697-4008-408.
 - Programming software allows a choice between Modem mode and Loader mode. Loader mode is the analog equivalent to the DL-3400.

PROGRAMMING AND SETUP

Programming of the DL-3400 and Guardian is done using unique FPS for each transceiver. Since both transceivers are transparent in their operation with the application there is no need to be concerned about Master and Remote configuration.

The first step in adding a Guardian into an existing system is to read the parameters of the DL-3400. Log parameter settings so that a thorough record is available for programming the Guardian. See the following figures.

Figure 39 DL-3400 Setup Parameters – Parameters

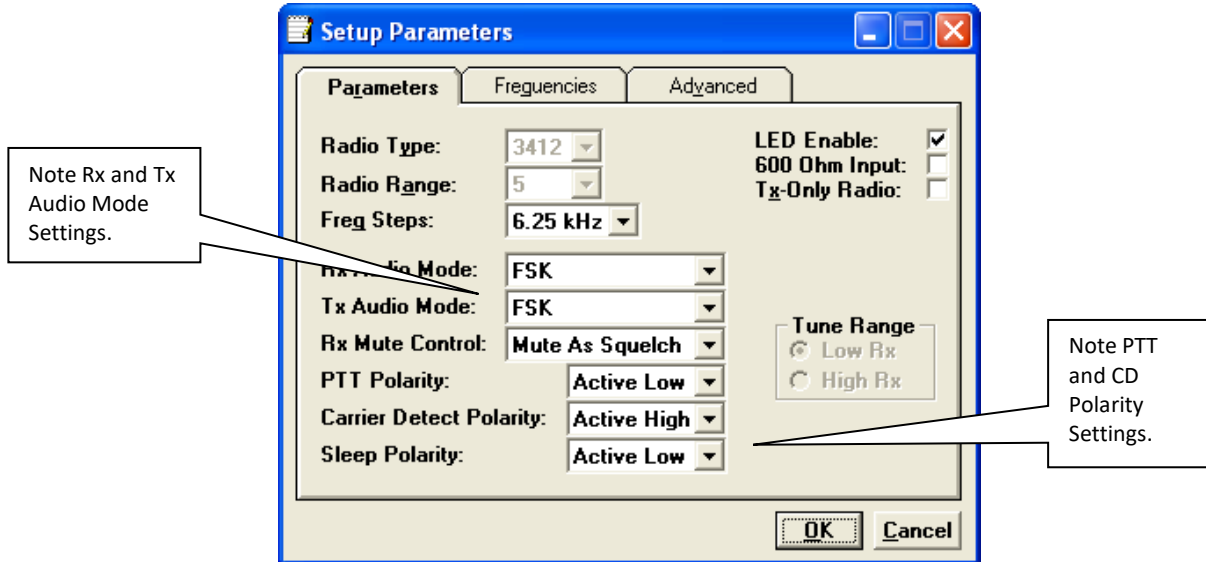

Figure 40 DL-3400 Setup Parameters – Frequencies

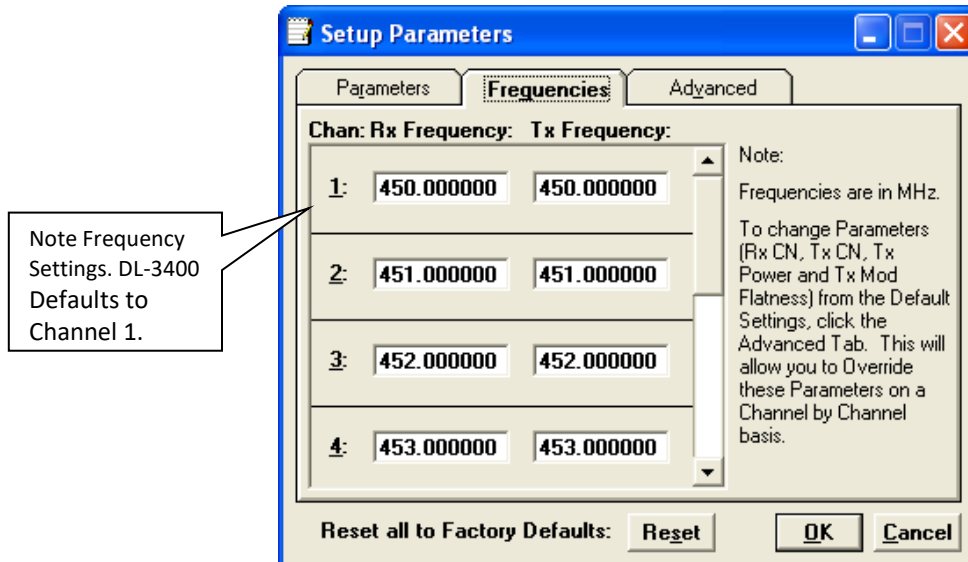
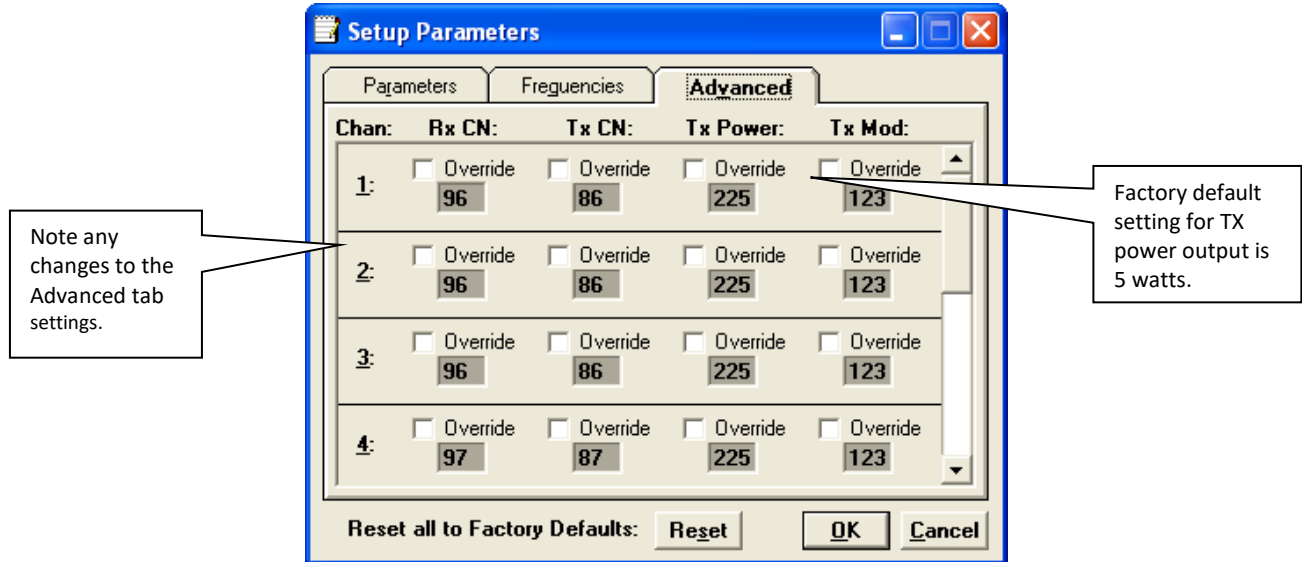

Figure 41 DL-3400 Setup Parameters – Advanced



SET GUARDIAN PARAMETERS

Once the parameters for the existing DL-3400 system are logged, connect the Guardian to proper power supply voltage (10-30 VDC 60 watt maximum at 10-watt RF power), Connect antenna port to 50 ohm termination. Connect DE-9 to DE-9 data cable (PN 687-4008-408 or equivalent) to Guardian Setup port.

Note: Guardian FPS default communication port is COM1. Change this if necessary.

- Programming parameters are 57,600, N, 1, DTR – None.
- Handshaking should be set to **Buffered with no HS**.

With the Guardian connected to a proper power source, antenna terminated, and programming cable connected to the **Setup** port of the Guardian, click **Config** (at the upper left corner of the programming window) to access the Guardian Configuration window.

Figure 42 Config button



The Guardian FPS will read and display the current configuration of the Guardian that is connected to the computer. See the following figure. Selecting Loader mode will change the configuration screen to allow analog radio settings.

Figure 43 User Configuration – Loader Mode

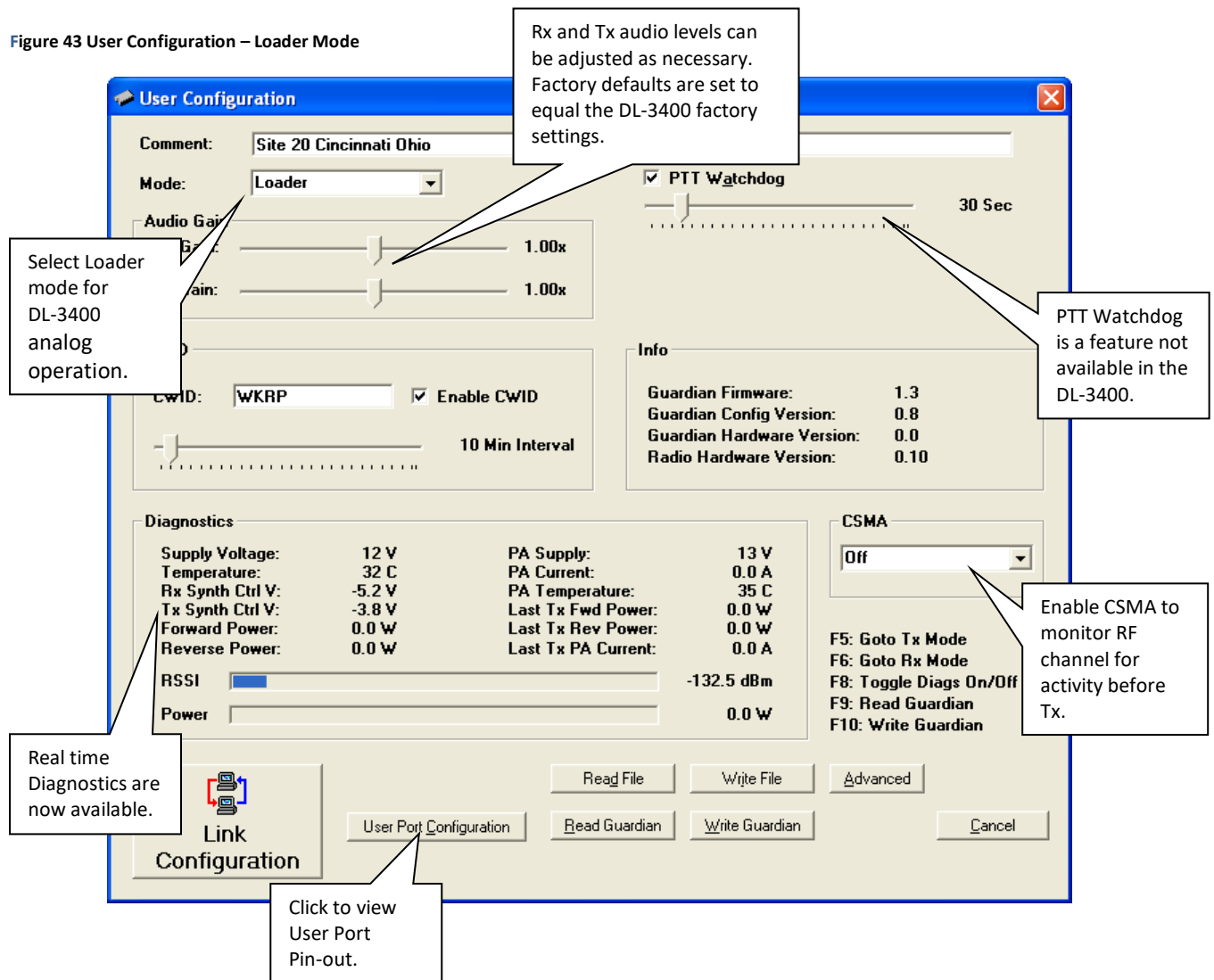

- The PTT Watchdog performs the same function as in the T-96SR. This can be adjusted or left at the factory default.
Note: This feature is not available in the DL-2400 transceiver.
- Information and real-time diagnostics are available in this window.
- CWID is a feature not available in the DL-3400. Station or License call signs can be transmitted at selected intervals. This feature is used when the analog system shares a “voice channel” with another system and is required to identify itself using Morse code.
- The Guardian Rx and Tx audio levels are preset to match the DL-3400 factory levels. These can be adjusted as necessary for the user’s application. Refer to Chapter 5 Guardian Field Programming Software in this User Manual for additional information.
- CSMA (Carrier Sense Multiple Access) is a feature available in the Guardian that is not available in the DL-3400.
 - o This feature allows the radio to monitor the RF channel for activity.
 - o There are two modes to select from when CSMA mode is enabled:
 - No Tx when the radio/modem is receiving valid user data.
 - No Tx when the radio/Modem is receiving an RF carrier.
 - See the Loader mode Figure that follows.
- There is a feature of the Guardian that allows the radio to be used as a modem (T-96SR compatible) or to be used as an analog radio (DL-3400 compatible). For this application only the Loader mode will be used.

LINK CONFIGURATION

Click Link Configuration to advance to the modem settings. This is the window where you set the RF channel frequencies and Loader settings. See the following figure.

Figure 44 Link Configuration – Loader Mode, default tab

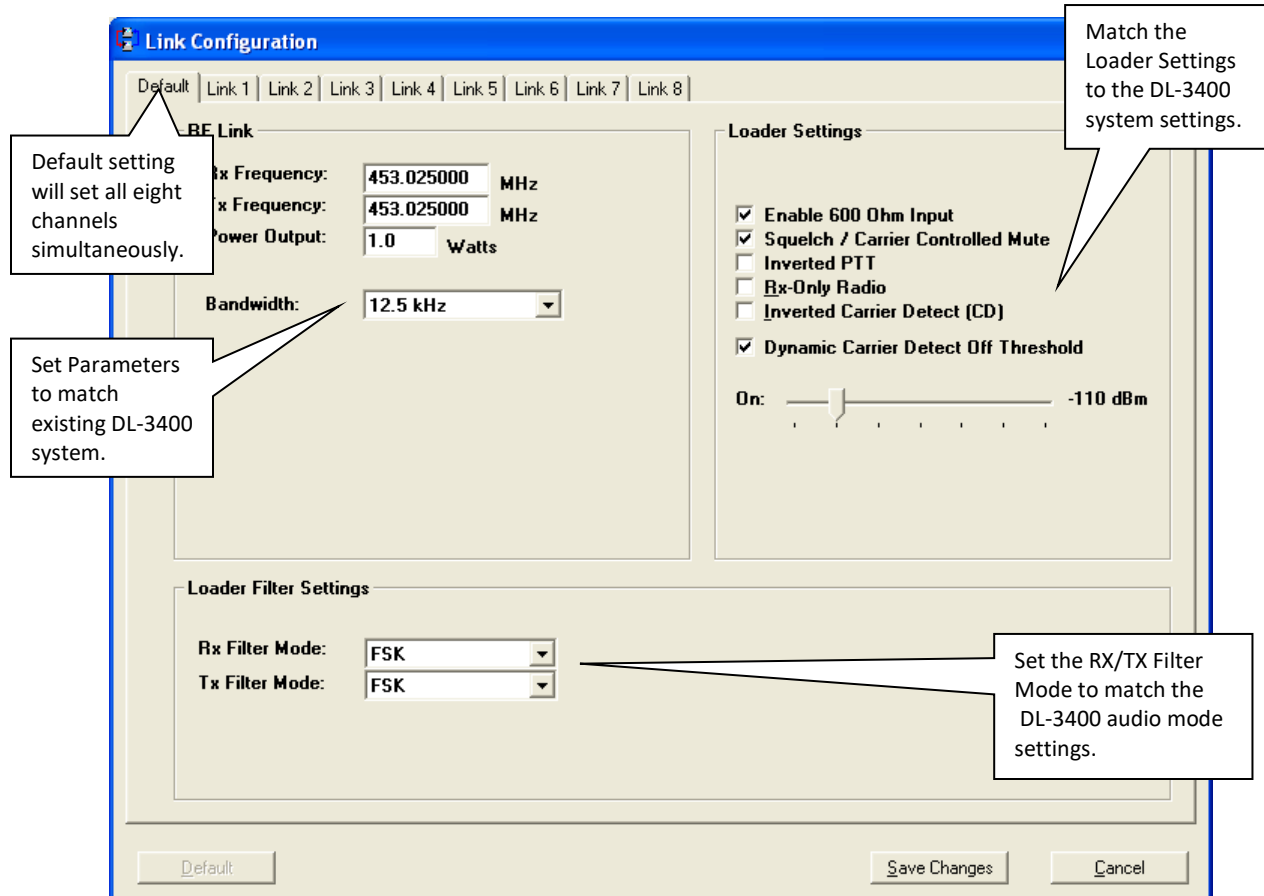

Unlike the DL-3400 where all eight channels were programmed one channel at a time, the Guardian has a Default tab where you can select settings that will be default selections for all eight link channels, making it easy to set all eight channels simultaneously (as shown in the previous figure).

- Using the information gathered from the DL-3400 programming, set the RF Link information to match the system parameters.
- Channel bandwidth is now selectable for either 25 kHz or 12.5 kHz.
- Set the Tx Output Power to the desired power level: 1-10 Watts.
- Select the Rx and Tx Filter Mode to match the DL-3400 Rx/Tx Audio Mode.

Refer to the parameters gathered from the DL-3400 programming to set the Loader Settings. Set Squelch, PTT Polarity, Rx/Tx audio impedance to match the DL-3400 system settings.

Dynamic Carrier Detect acts the same as in the T-96SR. The Carrier Sense level is set by selecting the "On" level. This is the RSSI (Receive Signal Strength Indication) or signal strength required to open the squelch setting in the receiver. The Carrier Sense "Off" level is set automatically to 5 dBm below the "On" level that is set using the slider control.

Important: When all parameters are selected and verified to be correct, click **Save Changes** at the bottom of the Link Configuration window to save the changes. The Link Configuration window will close.

The User Port pin-out configuration can be displayed by clicking the User Port Configuration in the User Configuration window.

Figure 45 User Port Configuration window

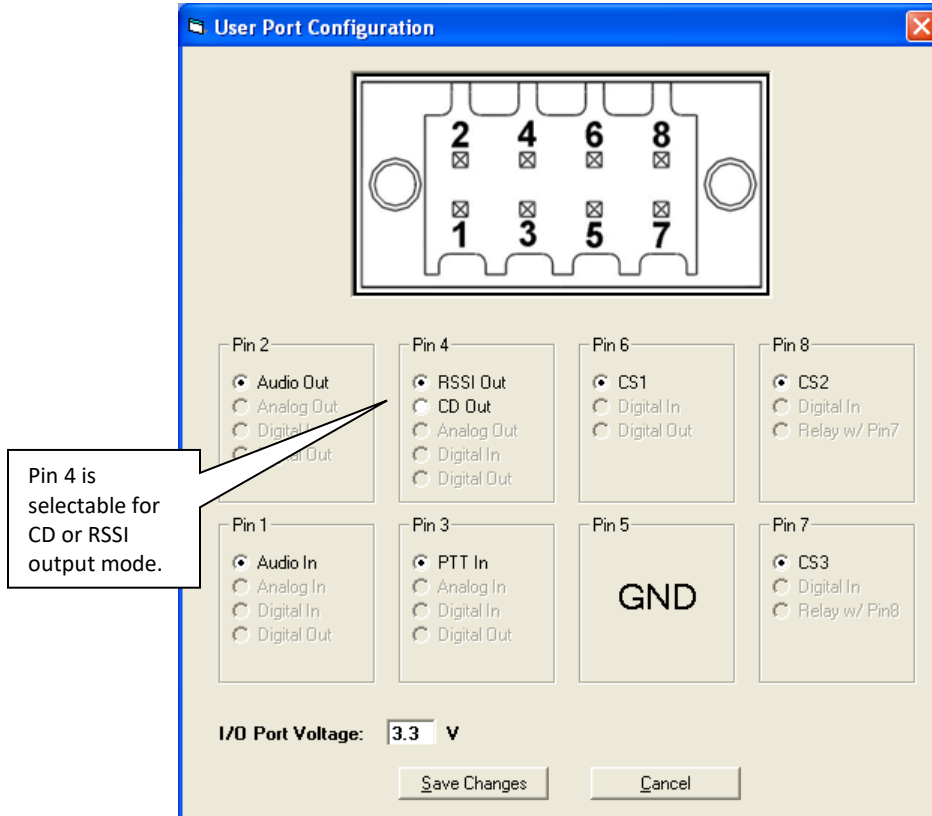

In Loader mode, the user port controls the analog radio functions. Pin 4 can be programmed to provide a Carrier Detect (CD) output 0-5 VDC or 5-0 VDC. Pin 4 can also be programmed to output the receiver RSSI level as DC voltage allowing it to be used for system monitoring and control.

The following table shows user interface pin functions about the DL-3400 wiring and cable color code.

Table 17 Pin function comparison – Guardian and DL-3400

Guardian		DL-3400		
Pin	Function	Pin	Function	Wire Color
Pin 1	Audio In (Tx)	Pin 8	Tx Audio	Yellow wire
Pin 2	Audio Out (Rx)	Pin 10	Rx Audio	White wire
Pin 3	PTT In	Pin 6	Tx PPT	Orange wire
Pin 4	CD / RSSI Out	Pin 7	CD Output	Gray wire
Pin 5	Ground	Pin 9	DC Ground	Black wire
Pin 6	CS1 (Channel Select)	Pin 3	Frequency Select	Violet wire
Pin 7	CS3	N/A		
Pin 8	CS2	N/A		

Note: The Guardian provides for 8 channel selection on the User Interface port. The DL-3400 allows selection of Channel 1 or 2 on the 10-pin user interface connector. The remaining channel selection is done using 3 pins on the DE-9 programming connector of the DL-3400.

PROGRAMMING

There are two options for programming the Guardian. There is a Write Guardian button in the User Configuration window of the FPS for programming. The other option is to press F10 on the computer keyboard. See the following figure.

Figure 46 User Configuration – Loader Mode

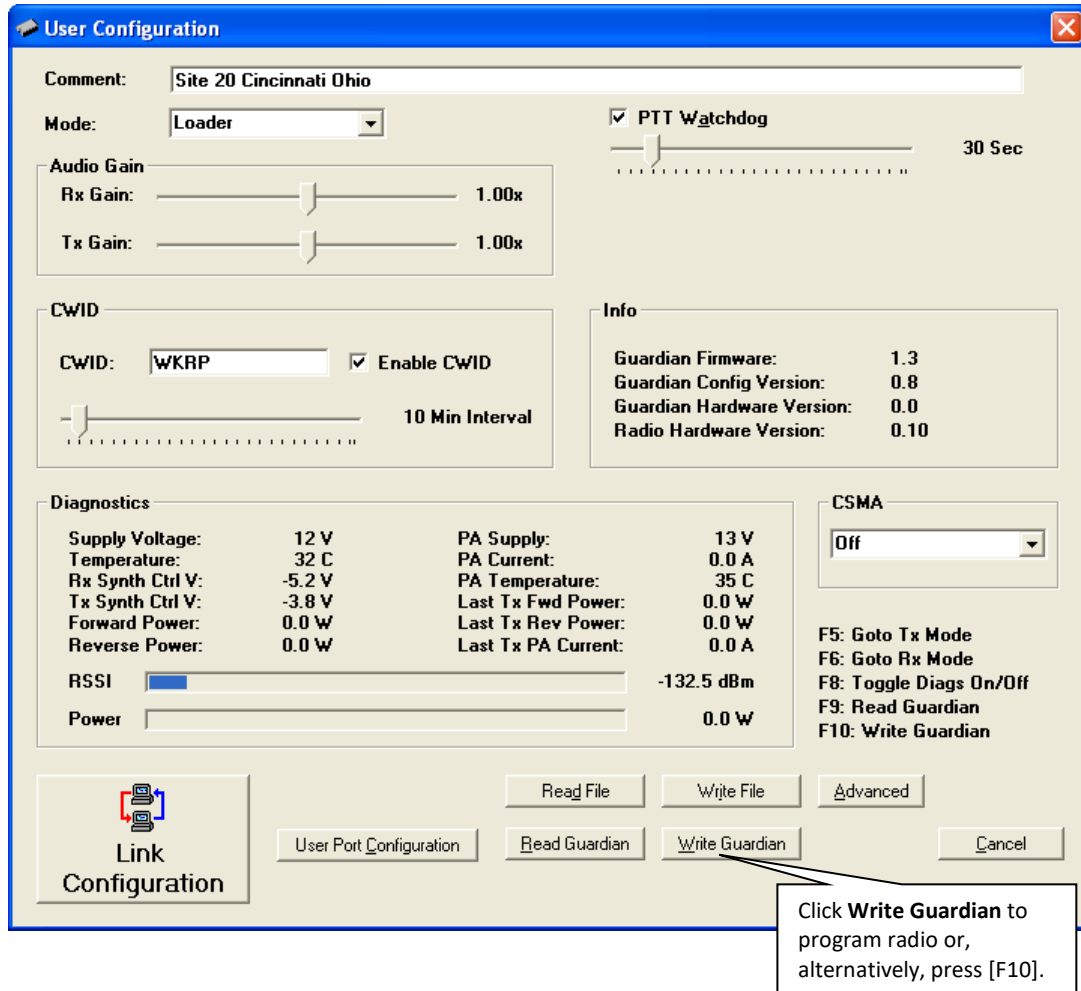

Programming of the Guardian is extremely fast. The message “Guardian Configuration Write Complete” appears. Click **OK**.

Figure 47 Guardian Configuration Write Complete



The Guardian has now been configured and is ready for installation.

INSTALLATION

As noted earlier, the Guardian footprint is different than the DL-3400.

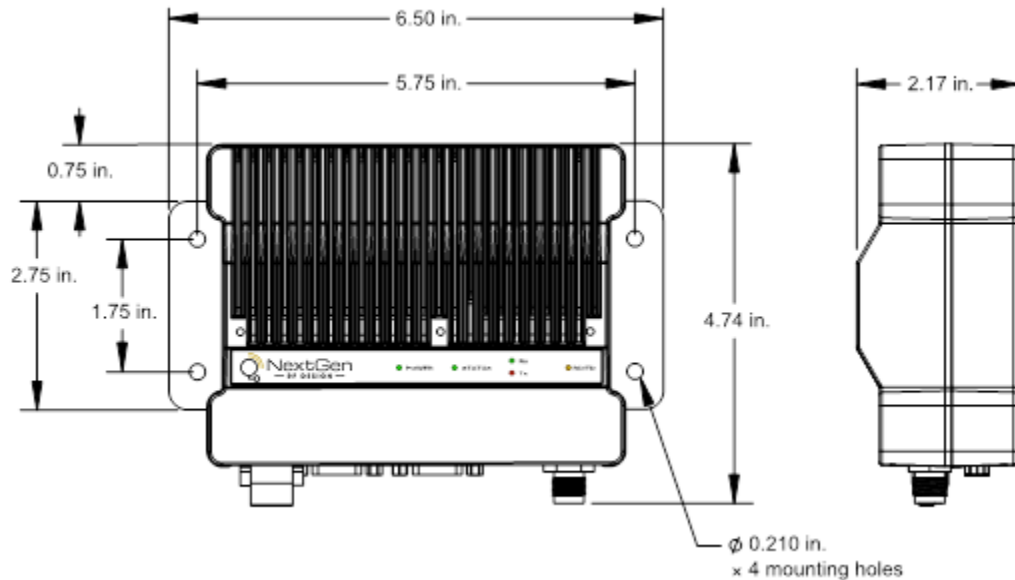

Figure 5 shows the mechanical dimensions for the Guardian. When mounting the Guardian, orientation should allow unrestricted airflow from the heat sink fins. If location, heat dissipation, or duty cycle are a concern, the addition of the Guardian Fan Kit may be considered. See Table 9 for a list of fan kits that are available for use with the Guardian.

Contact your sales representative for further information.

Antenna connection is a TNC Female 50-ohm connector. See **Error! Reference source not found.** for available Coaxial Adapter Cables from NextGen RF.

Analog connection is an 8-pin plug-in connector with tension clamp contacts. Radio control and signal connections are made by inserting either insertion tool PN 250-5006-001 or a small screwdriver into the connector.

- Strip wire to a maximum of 5/16 in. or 7 mm for insertion into the connector.
- Wire size is from 28 AWG to 18 AWG and can be either stranded or solid.
- Insert insertion tool or screwdriver into the socket corresponding to the appropriate pin and insert wire.
- Remove insertion tool or screwdriver and wire should be locked in place.
- Follow the same procedure for removal of wires if necessary.

For technical assistance, contact NextGen RF Technical Service at support@NextGenRF.com.

APPENDIX C — UL INSTALLATION INSTRUCTIONS

UL acceptance requires the following installation instructions. These installation instructions are available and may be downloaded from the www.NextGenRF.com website listed on the NextGen RF Product Information Card provided with each unit and include the following:

1. This equipment is suitable for use in Class I, Division 2, Groups A, B, C, and D or non-hazardous locations only.



WARNING — EXPLOSION HAZARD — Do not disconnect equipment unless power has been removed or the area is known to be non-hazardous.



WARNING — EXPLOSION HAZARD — Substitution of components may impair suitability for Class I, Division 2.

2. The unit is to be powered with a Listed Class 2 or LPS power supply rated at 10 to 30 VDC or equivalent.
3. Device must be installed in an end-use enclosure.
4. All wiring routed outside the housing, except for the antenna, must be installed in grounded conduit, following acceptable wiring methods based on installation location and electrical code.
5. The USB and SIM connectors are for temporary connection only during maintenance and setup of the device. Do not use, connect, or disconnect unless the area is known to be non-hazardous. Connection or disconnection in an explosive atmosphere could result in an explosion.
6. Do not operate reset switch unless area is known to be non-hazardous.

APPENDIX D — GUARDIAN AND DL-3282 MODEM INTERFACE

This appendix provides information for the implementation of the Guardian wireless modem/analog radio and the DL-3282.

Figure 48 Guardian Serial Radio and DL-3282 Modem



APPLICABLE PRODUCTS

Guardian X00 Wireless Modem / Analog Radio and DL-3282.

APPLICATION

The Guardian Wireless Modem/Analog Radio can operate at VHF, 200 MHz, UHF, and 900 MHz frequencies. The radio will operate at 25 kHz or 25 kHz of bandwidth. The Guardian will operate as a modem or analog radio. The user can select the operating mode by using the Guardian FPS (Field Programming Software) and selecting the proper bandwidth and mode of operation. Refer to Chapter 1 Guardian Overview for additional information about Guardian frequency ranges and modes of operation.

The DL-3282 is an analog modem that can be set to operate in Bell 202 or Bell 103 standards format. Bell 202 is a 1200 Baud FSK data format. Bell 103 is a 300 Baud FSK data format.

HARDWARE

The Guardian uses the following connections

- Antenna connector
 - o TNC Female connector
 - o Full Duplex version
 - TNC Female connector for Transmit (Tx).
 - SMA Female connector for Receive (Rx).
- Power connection
 - o Guardian uses a 4-pin power connector.
 - o Power cable is included with the Guardian.
 - Power cable NextGen RF PN 897-5008-010.
 - o 3-wire connection for power

- Red — B+
 - Black — Ground
 - White — B+ (must be connected to red B+)
 - Power input: 10-30 VDC at 60 watts maximum.
- Interface connection
- Guardian uses an 8-pin User Port interface connector.
 - Connector is included with the Guardian.
 - Connector NextGen RF PN 415-1001-208.
 - Wire connections can be opened with insertion tool PN 350-5006-001 or a small screwdriver.

The DL-3282 Modem uses the following connections

- User Interface
- 10-pin 3M ribbon-style connector.
 - 25-pin DB-25 female RS-232 serial data connector.
 - DE-15 high density serial connector — special purpose connection.
- Power connection
- Power is applied to the DL-3282 through the 10-pin ribbon-cable connection.
 - Power input: 7-16 VDC at 50 mA (Max.)
 - Use cable NextGen RF PN 023-3410-109 for power and interface to the Guardian.

PROGRAMMING AND SETUP

Use the Guardian FPS (Field Programming Software) to program the Guardian. Guardian FPS is available by contacting support@nextgenrf.com.

When the Guardian is being interfaced with an existing DL-3400 or DL-3282 radio modem system, the Guardian must be programmed to match the settings of the DL-3400 analog radios. Information for programming a Guardian into a DL-3400 system is provided in the previous Appendix, APPENDIX B — Guardian and DL-3400 Interoperability. Detailed information for programming the Guardian is also provided in Chapter 5 Guardian Field Programming Software in this User Manual.

The following programming steps will provide much of the information required to operate the Guardian in an analog data system.

Set Guardian Parameters

Once the parameters for the existing DL-3400 have been logged, connect the Guardian to the proper power supply voltage (10-30 VDC 60 watt maximum at 10-watt RF power). Connect the DE-9 to DE-9 data cable (NextGen RF PN 697-4008-408 or equivalent) to the Guardian **Setup** port.

Note: The Guardian FPS is set for COM1 by default. Change this if necessary.

- Programming parameters are 57,600, 8, N, 1, DTR, None.
- Handshaking should be set to Buffered with no HS.

With the Guardian connected to proper power source, antenna terminated, and programming cable connected to the **Setup** port of the Guardian, click **Config** (at the upper left corner of the programming window) to access the Guardian Configuration window.

Figure 49 Config button



The Guardian FPS will read the current configuration of the Guardian that is connected to the computer and display its configuration settings.

Figure 50 User Configuration – Loader Mode

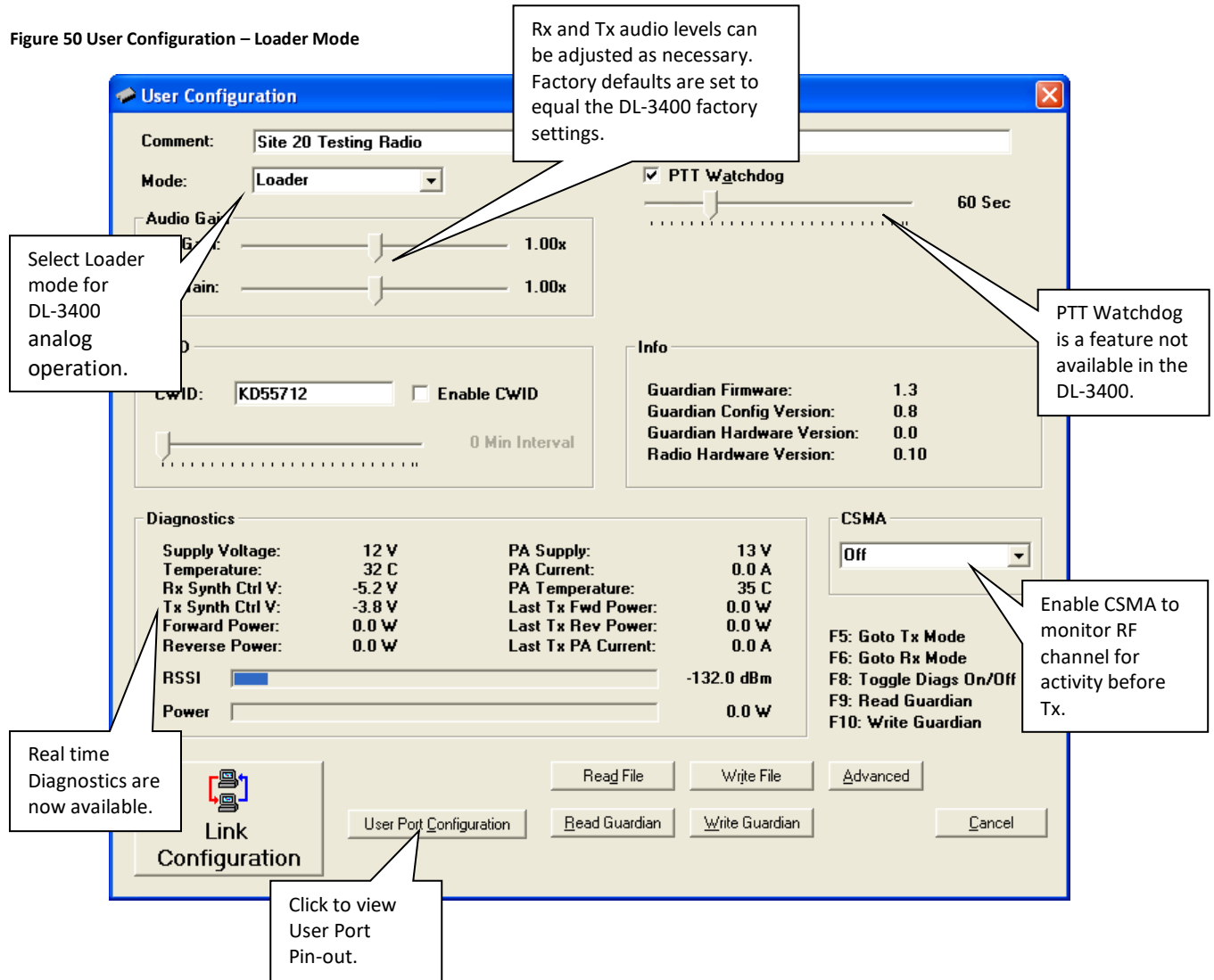

- The PTT Watchdog performs the same function as in the T-96SR. This can be adjusted or left at the factory default.
Note: This feature is not available in the DL-2400 transceiver.
- Information and real-time diagnostics are available in this window.
- CWID is a feature not available in the DL-3400. Station or License call signs can be transmitted at selected intervals. This feature is used when the analog system shares a “voice channel” with another system and is required to identify itself using Morse code.
- The Guardian Rx and Tx audio levels are preset to match the DL-3400 factory levels. These can be adjusted as necessary for the user’s application. Refer to Chapter 5 Guardian Field Programming Software in this User Manual for additional information.
- CSMA (Carrier Sense Multiple Access) is a feature available in the Guardian that is not available in the DL-3400.
 - o This feature allows the radio to monitor the RF channel for activity.

- There are two modes to select from when CSMA mode is enabled:
 - No Tx when the radio/modem is receiving valid user data.
 - No Tx when the radio/Modem is receiving an RF carrier.
 - See the Loader mode Figure that follows.
- There is a feature of the Guardian that allows the radio to be used as a modem (T-96SR compatible) or to be used as an analog radio (DL-3400 compatible). For this application only the Loader mode will be used.

Link Configuration

Click Link Configuration to open the Link Configuration window to access the modem settings. This is the window where you set the RF channel frequencies and Loader settings. See the following figure.

Figure 51 Link Configuration – Loader Mode, default tab

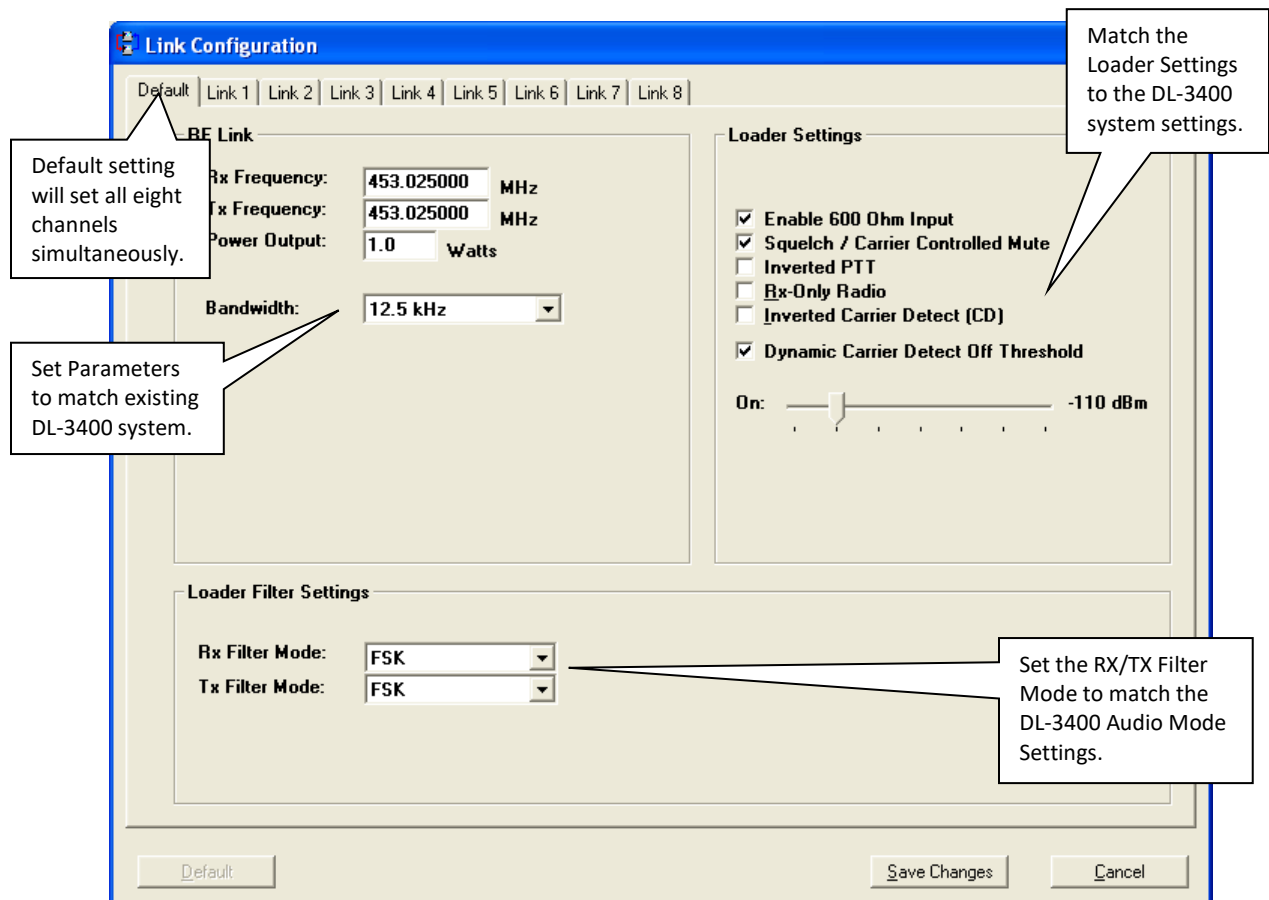

Unlike the DL-3400 where all eight channels were programmed one channel at a time, the Guardian has a Default tab where you can select settings that will be default selections for all eight link channels, making it easy to set all eight channels simultaneously. (See the figure above.)

- Using the information gathered from the DL-3400 programming, set the RF Link information to match the system parameters.
- Channel bandwidth is now selectable for either 25 kHz or 12.5 kHz.
- Set the Tx Output Power to the desired power level: 1 to 10 Watts.
- Select the Rx and Tx Filter mode to match the DL-3400 Rx/Tx Audio mode. (See the preceding figure.)

Refer to the parameters gathered from the DL-3400 programming to set the Loader Settings. Set Squelch PTT Polarity, Rx/Tx audio impedance to match the DL-3400 settings. (See the preceding figure.)

Dynamic Carrier Detect acts the same as in the T-96SR. The Carrier Sense level is set by selecting the “On” level. This is the RSSI (Receive Signal Strength Indication) or signal strength required to open the squelch setting in the receiver. The Carrier Sense “Off” level is set automatically to 5 dBm below the “On” level. (See the preceding figure.)

Important: When all parameters are selected and verified to be correct, click **Save Changes** at the bottom of the Link Configuration window to save the changes. The Link Configuration window will close.

Click User Port Configuration in the User Configuration window to display the User Port pin-out configuration. (See the following figure.)

Figure 52 User Port Configuration window

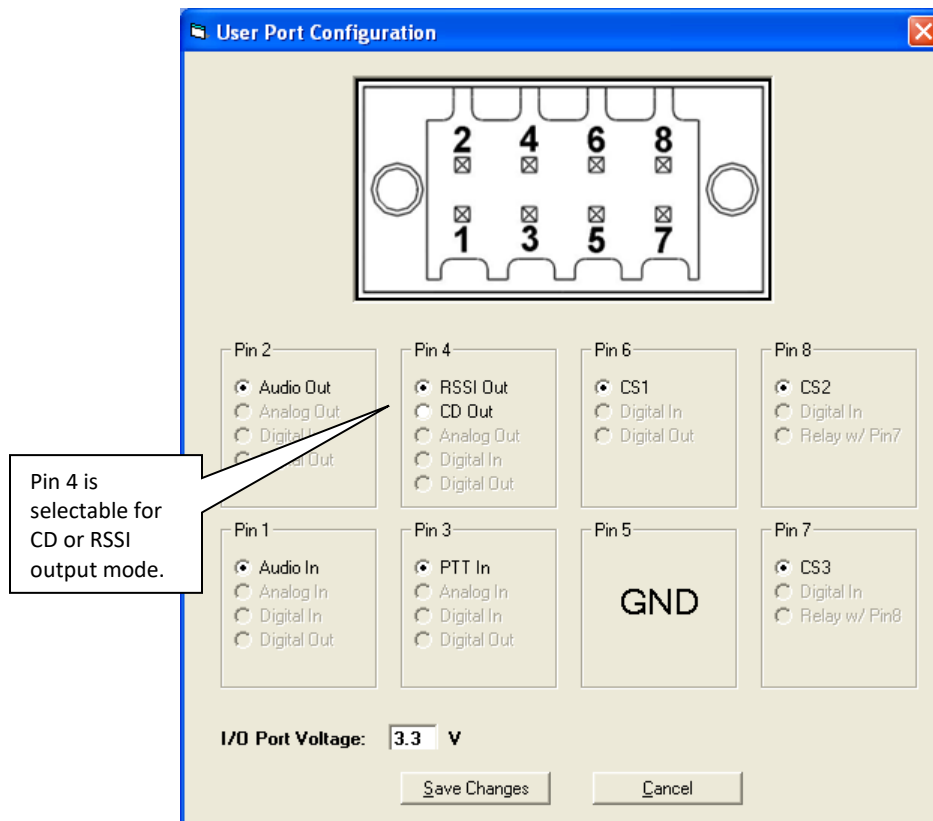

In Loader mode, the User Port controls the analog radio functions. Pin 4 can be programmed to provide a Carrier Detect (CD) output 0-5 VDC or 5-0 VDC. Pin 4 can also be programmed to output the receiver RSSI level as a DC voltage allowing it to be used for system monitoring and control (see the preceding figure).

Note: For this modem application, Pin 4 should be set for CD output. DC polarity should not be inverted as the DL-3282 modem is expecting to see a -0-5 VDC change when an RF signal is present.

The following table shows user interface pin functions about the DL-3400 wiring and cable PN 023-3410-109 wire color code.

Table 18 Pin function comparison – Guardian and DL-3400 and 023-3410-109 cable wire colors

Guardian			DL-3400		
Pin	Function		Pin	Function	Wire Color
Pin 1	Audio In (Tx)		Pin 8	Tx Audio	Yellow wire
Pin 2	Audio Out (Rx)		Pin 10	Rx Audio	White wire
Pin 3	PTT In		Pin 6	Tx PPT	Orange wire
Pin 4	CD / RSSI Out		Pin 7	CD Output	Gray wire
Pin 5	Ground		Pin 9	DC Ground	Black wire
Pin 6	CS1 (Channel Select)		Pin 3	Frequency Select	Violet wire
Pin 7	CS3		N/A		
Pin 8	CS2		N/A		

Note: The Guardian provides for 8 channel selection on the User Interface port. The DL-3400 allows selection of Channel 1 or 2 on the 10-pin user interface connector. The remaining channel selection is done using 3 pins on the DE-9 programming connector of the DL-3400.

Programming

There are two options for programming the Guardian: click the Write Guardian button or press the [F10] key on the computer keyboard. See the following figure.

Figure 53 User Configuration – Loader Mode

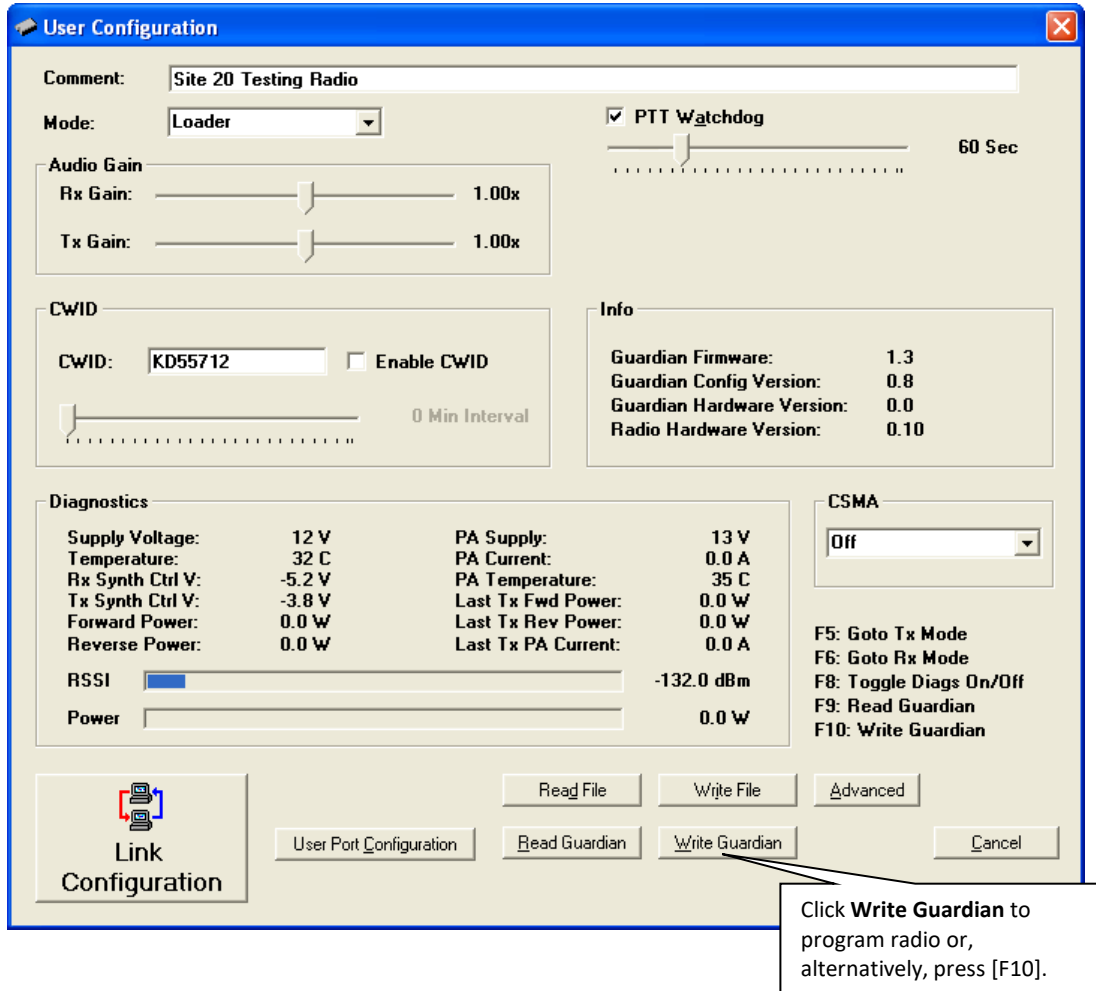

Programming of the Guardian is extremely fast. The message “Guardian Configuration Write Complete” appears. Click **OK**.

Figure 54 Guardian Configuration Write Complete

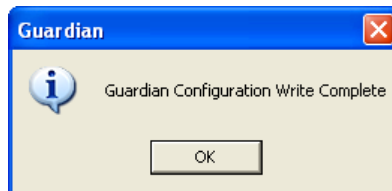

The Guardian has now been configured and is ready for installation.

DL-3282 INTERFACE TO GUARDIAN

The DL-3282 modem is connected to the Guardian using the 10-pin ribbon cable connection J102. See the following figure.

Figure 55 DL-3282 modem with 023-3410-109 interface cable connected to J102 10-pin user interface

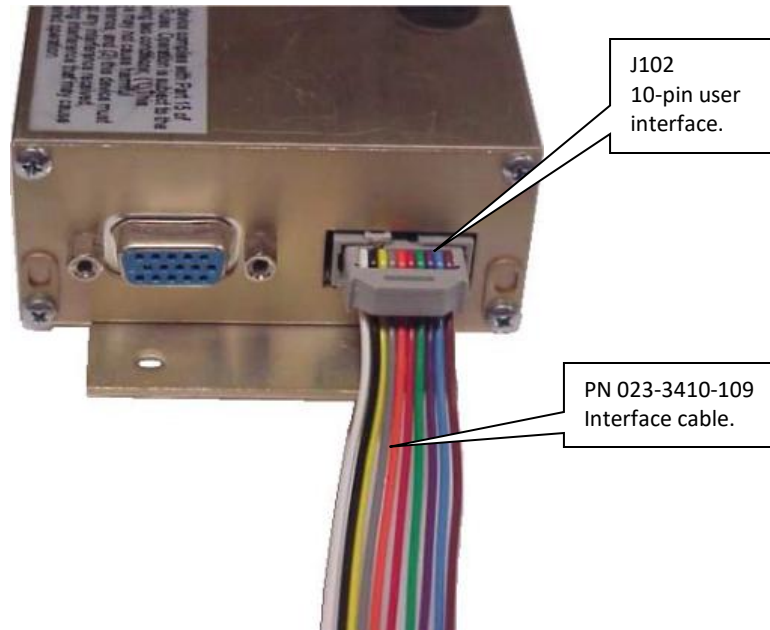

Interface wiring from the DL-3282 modem to the Guardian is accomplished by connecting the cable PN 023-3410-109 to the Guardian User Port interface connector as shown in Figure 56 which follows. This figure is not to scale and is for reference only. Cable length is determined by application. Figure 57 shows the User Port connector pin locations as viewed from the front of the Guardian.

Figure 56 Cable 023-3410-109 connection to the Guardian User Port interface connector

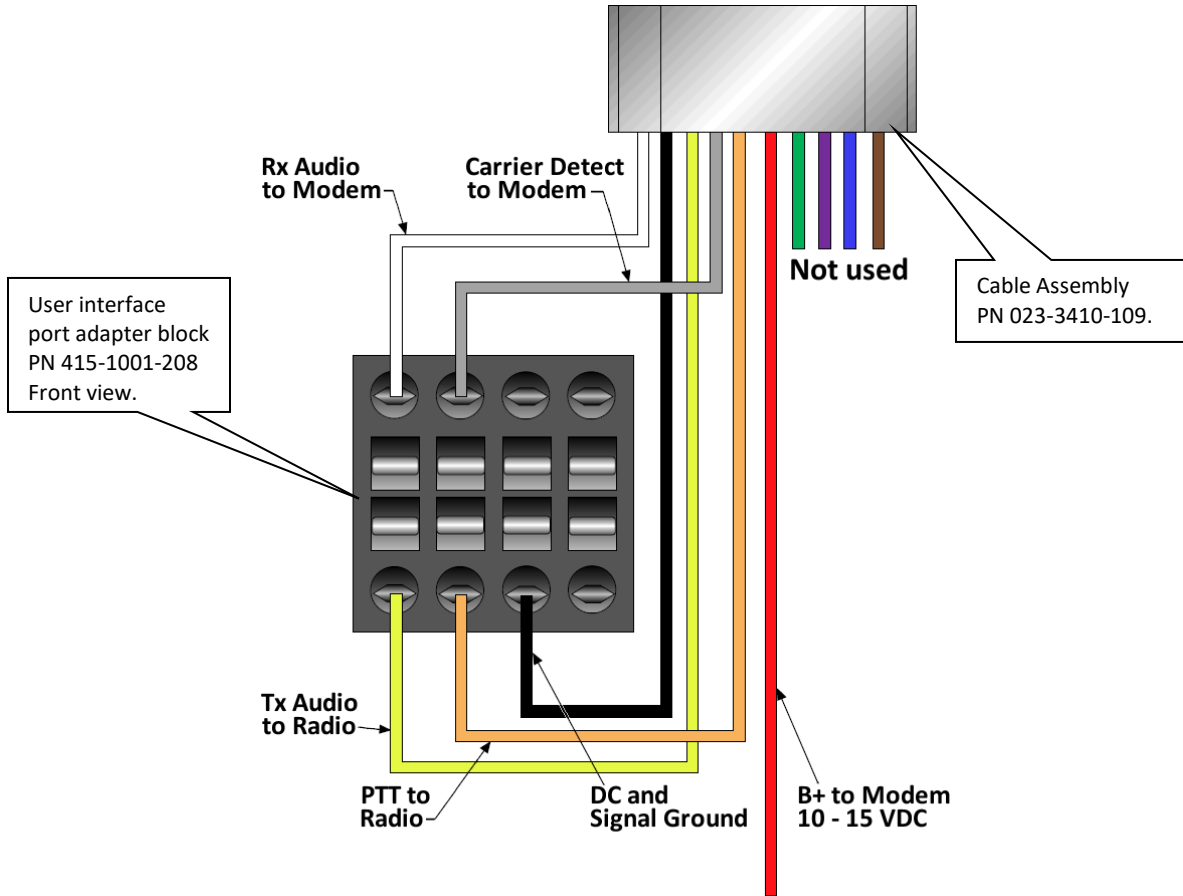
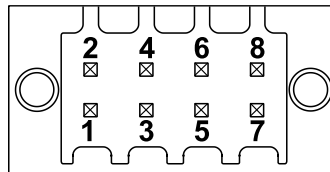

Figure 57 User Interface Port Connector



The following figure shows the DL-3282 modem connected to the Guardian. The cable length and power connection is shown for reference only. Actual cable length and modem location will vary by application. The modem is shown fastened to the top of the Guardian using a #6-32 x 3/8 in. button head cap screw. This shows one possible way to mount the modem to the Guardian.

Figure 58 DL-3282 Modem connected and fastened to the Guardian



PROGRAMMING AND OPERATIONAL HINTS

- Normally the Guardian will be programmed for FSK mode since this mode provides flat audio response for data applications.
- When interfacing into an existing DL-3400 / DL-3282 radio modem system, always verify the DL-3400 programmable parameters and program the Guardian accordingly.
- Information about the DL-3282 is available in the technical manual PN 001-3282-003. Contact the NextGen RF Wireless Networks Group, support@NextGenRF.com, for manual availability.
- The DL-3282 modem is programmed using a series of DIP switches located inside the modem. Default settings are Bell 202 with Equalizer, CD – Active High, Normal mode – On, RTS/CTS delay – 240 mSec.
- Guardian CD polarity should be set for Active High, which is the default setting of the Guardian CD parameter.
- Ensure that Pin 4 of the User Port interface is set for CD output.

Note: The Guardian can operate from 10 to 30 VDC. The DL-3282 modem can operate from 7 to 16 VDC. Care must be taken to prevent overvoltage damage to the DL-3282 modem.

For technical assistance, contact NextGen RF Wireless Network Group Technical Service at support@NextGenRF.com.

APPENDIX E — GUARDIAN AND T-96SR INTEROPERABILITY

This appendix provides information for the implementation of the Guardian Wireless Modem into an existing T-96SR wireless data system.

Figure 59 Guardian Serial Radio and T-96SR Wireless Modem



APPLICABLE PRODUCTS

Guardian X00 Wireless Modem / Analog Radio, T-96SR Wireless Modem.

APPLICATION

The T-96SR is a wireless modem that operates in the VHF, UHF, and 900 MHz frequency bands. The radio will operate at 25 kHz or 12.5 kHz bandwidth depending on the part number that is ordered.

The Guardian wireless modem can operate in the VHF, 200 MHz, UHF, and 900 MHz frequency bands. The radio will operate at 25 kHz or 12.5 kHz of bandwidth. The user can select the operating mode by using the Guardian FPS (Field Programming Software) and selecting the proper bandwidth. Refer to Chapter 1 Guardian Overview for additional information about Guardian frequency ranges and bandwidth operation.

The Guardian and T-96SR are over-the-air (OTA) compatible. The Guardian will be configured through the FPS to match the parameters of the existing T-96SR system.

HARDWARE

Although the Guardian and T-96SR are OTA compatible, there are physical differences between the two product lines.

- Antenna connector
 - o T-96SR – Female SMA connector
 - o Guardian – Female TNC connector
 - o See Table 10 for a list of Coaxial Adapter Cables that are available for use with the Guardian.
- Power connection
 - o T-96SR utilizes a red and black wire from the data cable.
 - Power input: 10-15 VDC at 3 Amps maximum.

- Guardian uses a 4-pin power connector.
 - 3 wire connection. The white wire must be connected to B+.
 - Power cable is included with the Guardian.
 - Power cable PN 897-5008-010
 - Power input: 10-30 VDC at 60 watts maximum.

- Data connection
 - T-96SR uses a DE-15 connector
 - T-96SR application cable connects from a DE-15 to a DE-9 standard serial connection, PN 697-0000-001.
 - Guardian uses a DE-9 standard serial connection and can use standard DE-9 to DE-9 cable, PN 697-4008-408.
 - Guardian does not require special application cables like the T-96SR.
 - If the T-96SR currently in place is being replaced, there is likely a PN 697-0000-001 cable from the radio to the PCL/RTU equipment.
 - The PN 697-0000-001 cable could be removed and the PCL/RTU can be connected directly to the radio.
 - If cable length is an issue, a short DE-9 to DE-9 cable can be added between the PLC/RTU and the Guardian radio.

- Mechanical footprint
 - The T-96SR and the Guardian do not use the same mechanical footprint.
 - Reference Chassis Dimensions, earlier in this user manual, which shows the mechanical layout of the Guardian.
 - See page 7 section 1.4.7 Figure 5 for Chassis Dimensions.

- Programming
 - The Guardian uses programming software unique to the Guardian.
 - The Guardian programming cable is simply a standard DE-9 to DE-9 serial cable and no longer requires unique cabling.
 - Guardian programming cable is NextGen RF PN 697-4008-408.

PROGRAMMING AND SETUP

Programming of the T-96SR and Guardian is done using unique Field Programming Software (FPS) for each wireless modem. Since both wireless modems are transparent in their operation with the RTU/PLC there is no need to be concerned about Master and Remote configurations.

The first step in adding a Guardian into an existing system is to read the parameters of the T-96SR. Log parameter settings so that a thorough record is available for programming the Guardian. See the following figures.

Figure 60 T-96SR Setup Parameters – Modem

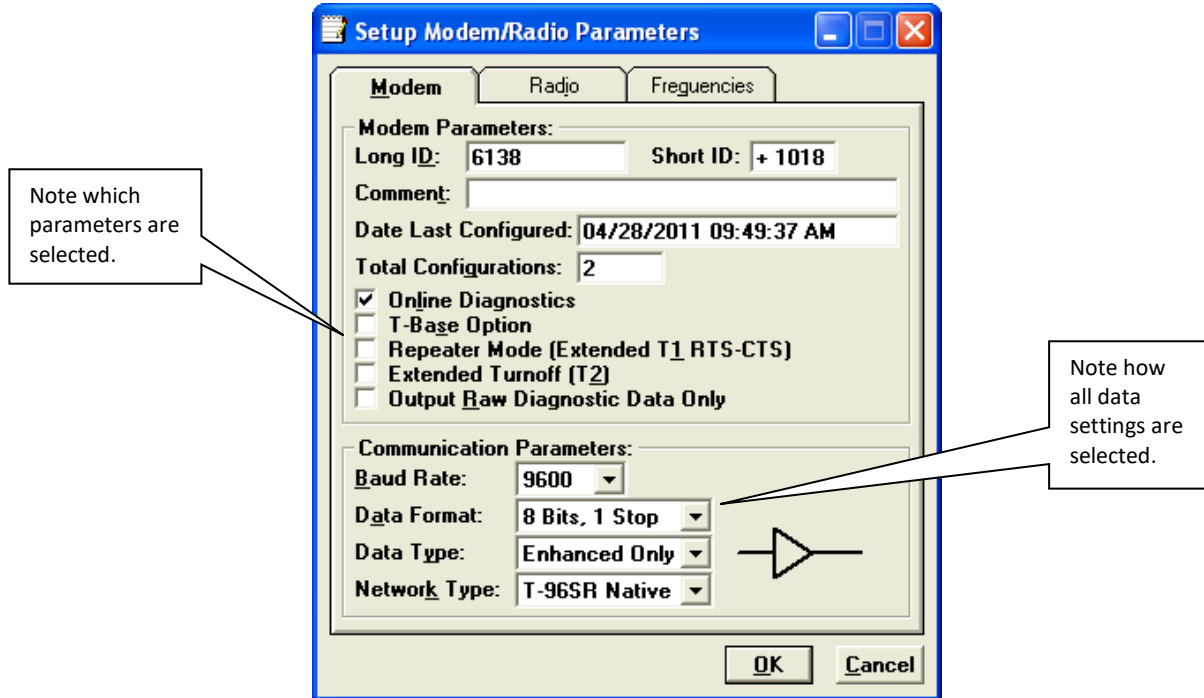

Figure 61 T-96SR Setup Parameters – Radio

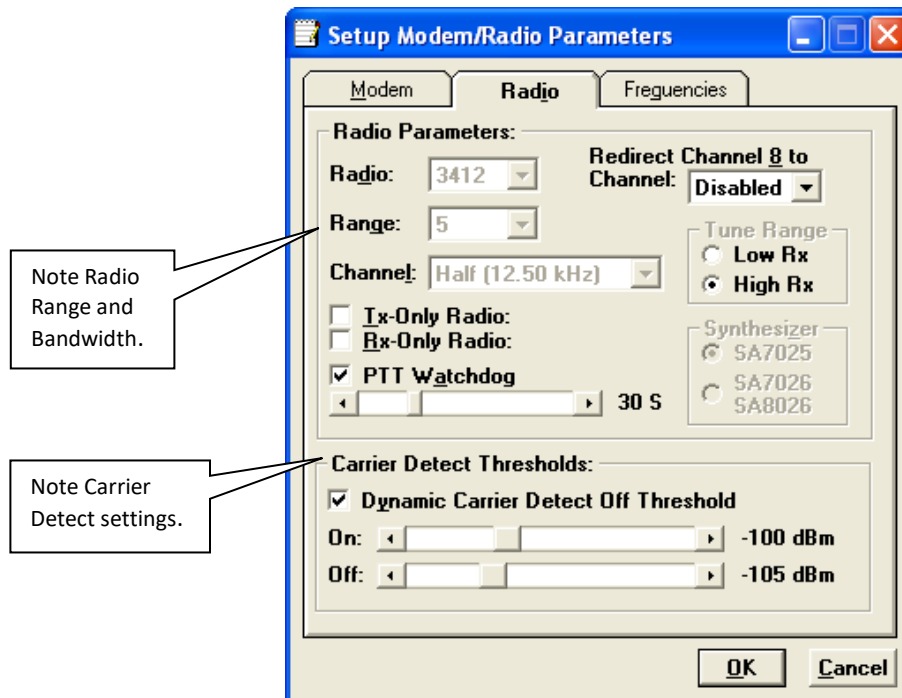
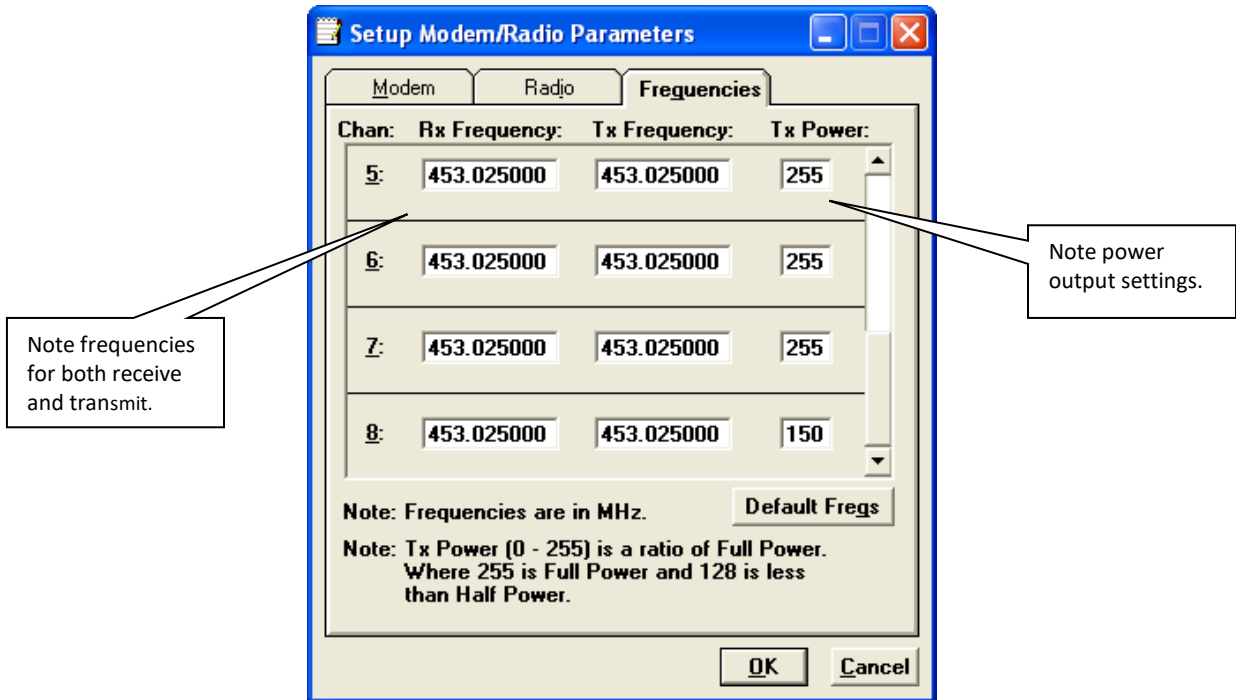

Figure 62 T-96SR Setup Parameters – Frequencies



Set Guardian Parameters

Once the parameters for the existing T-96SR system are logged, connect the Guardian to proper power supply voltage (10-30 VDC 60 watt maximum at 10-watt RF power). Connect the antenna port to 50-ohm termination. Connect DE-9 to DE-9 data cable (PN 697-4008-408 or equivalent to the Guardian **Setup** port).

Note: The Guardian FPS is set for COM1 by default. Change this if necessary.

- Programming parameters are 57,600, 8, N, 1, DTR, None.
- Handshaking should be set to Buffered with no HS.

With the Guardian connected to proper power source, antenna terminated, and programming cable connected to the **Setup** port of the Guardian, click **Config** (at the upper left corner of the programming window) to access the Guardian Configuration window.



The Guardian FPS will read the current configuration of the Guardian that is connected to the computer. The configuration window will display configuration settings of the Guardian, including the Long ID and Short ID of the Guardian. The Long ID is typically a six-digit number. This number can be changed to suit the application. See the following figure.

Figure 63 User Configuration – Modem Mode

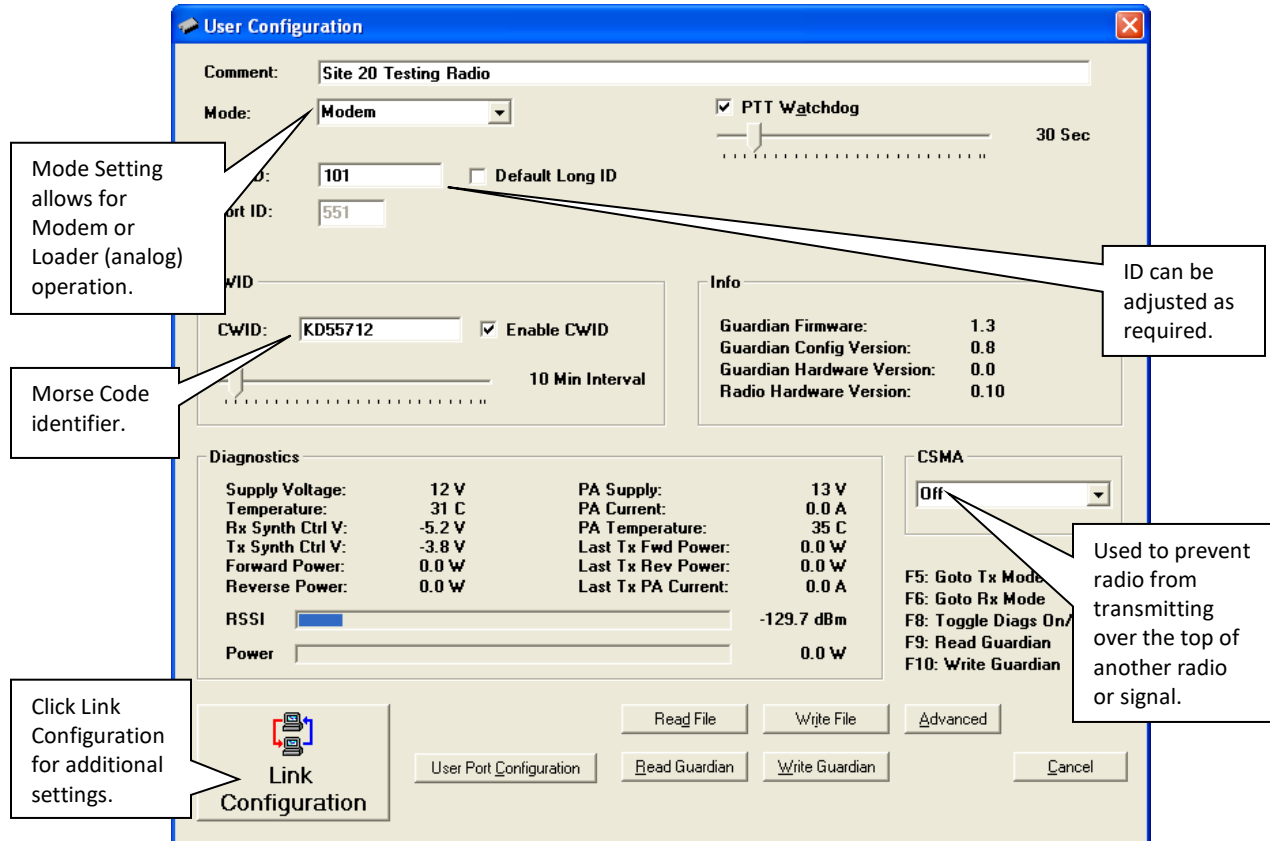

- The PTT Watchdog performs the same function as in the T-96SR. This can be adjusted or left at factory default.
- Information and real-time diagnostics are available in this window.
- CWID is a feature not available on the T-96SR. Station or license call signs can be transmitted at selected intervals. This feature is used when the analog system shares a “voice channel” with another system and is required to identify itself using Morse code.
- CSMA (Carrier-Sense Multiple Access) is a feature added to the Guardian that is not available on the T-96SR.
 - o This feature allows the radio to monitor the RF channel for activity.
 - o There are two modes to select from when CSMA mode is enabled:
 - No Tx when the radio/modem is receiving valid user data.
 - No Tx when the radio/modem is receiving an RF carrier.
- There is a new feature added to the Guardian that allows the radio to be used as a modem (T-96SR compatible) or to be used as an analog radio (DL-3400 compatible). For this application only the “Modem” mode will be used (previous figure).

LINK CONFIGURATION

Click Link Configuration to access the modem settings. This is the window where you set the RF channel frequencies and Loader settings. See the following figure.

Figure 64 Link Configuration Default tab – Modem Mode

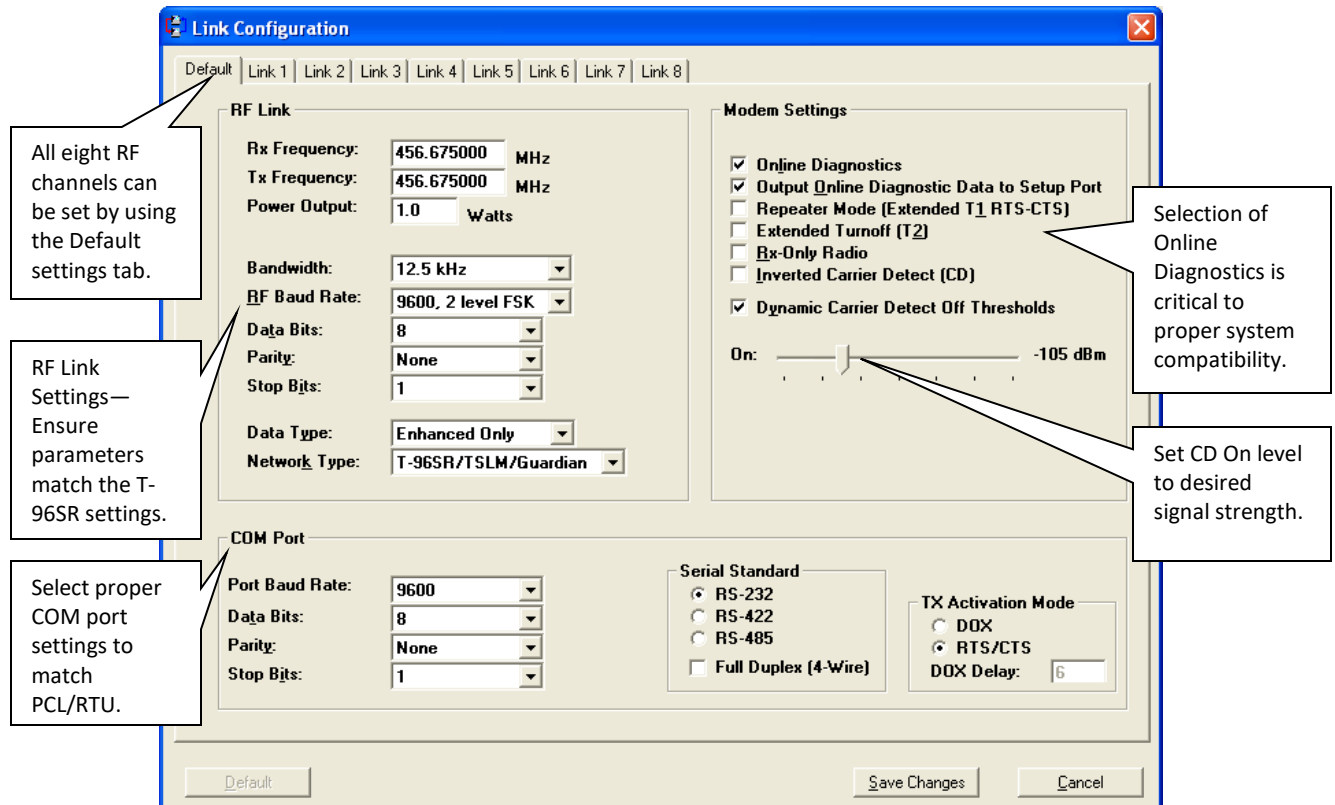

Unlike the T-96SR where all eight channels were programmed one channel at a time, the Guardian has a Default tab where you can select settings that will be default selections for all eight link channels, making it easy to set all eight channels simultaneously. (See the figure above.)

- Using the information collected from the T-96SR programming, set the RF Link information to match the system parameters.
- Channel bandwidth is now selectable for either 25 kHz or 12.5 kHz.
- Set the Tx Power Output to the desired power level: 1-10 Watts.
- The Guardian allows for the OTA data settings to be different from the user COM port settings. Care must be taken to ensure the OTA settings are the same as the T-96SR system settings.
 - o Channel bandwidth must match the existing system.
 - o Data rate (Baud rate) must be the same as the T-96SR.
 - o Data bits, Parity, and Stop bits must be the same as the T-96SR.
- The Guardian uses a slightly different yet compatible modulation scheme as the T-96SR.
 - o T-96SR uses DRCMSK modulation.
 - o Guardian uses 2 Level FSK.

Refer to the parameters collected from the T-96SR programming to set the Modem Settings. Pay close attention to the Online Diagnostics section. If Online Diagnostics are selected in the T-96SR system, they **must** be enabled in the Guardian. Whether or not the Online Diagnostics are output to the Setup port is left to the discretion of the customer.

By selecting Output Online Diagnostics Data to Setup Port, the end user can view Online Diagnostics the same as a T-Base Diagnostic Port would show them.

The remainder of the Modem Settings should match the T-96SR system. Dynamic Carrier Detect acts the same as the T-96SR. The Carrier Sense level is set by selecting the “On” level. This is the RSSI (Receive Signal Strength Indication) or signal strength required to open the squelch setting in the receiver. The Carrier Sense “Off” level is set automatically to 5 dBm below the “On” level.

The COM port settings must match the RTU/PLC equipment used in the system. Typically, these settings will be the same as the RF Link Settings but can be set differently. When used in an existing T-96SR system, these will be the same as the RF Link Settings.

- Select the correct Baud rate, Parity bit, and Stop bit values.
- Transmit control mode can be either RTS/CTS handshaking mode or DOX (Data Operated Transmit) mode.
- The Guardian also offers the choice of RS422 and RS485 serial connections.

Important: When all parameters are selected and verified to be correct, click **Save Changes** at the bottom of the Link Configuration window to save the changes. The Link Configuration window will close. There are two options for programming the Guardian: click the Write Guardian button or press the [F10] key on the computer keyboard. See the following figure.

Figure 65 User Configuration window

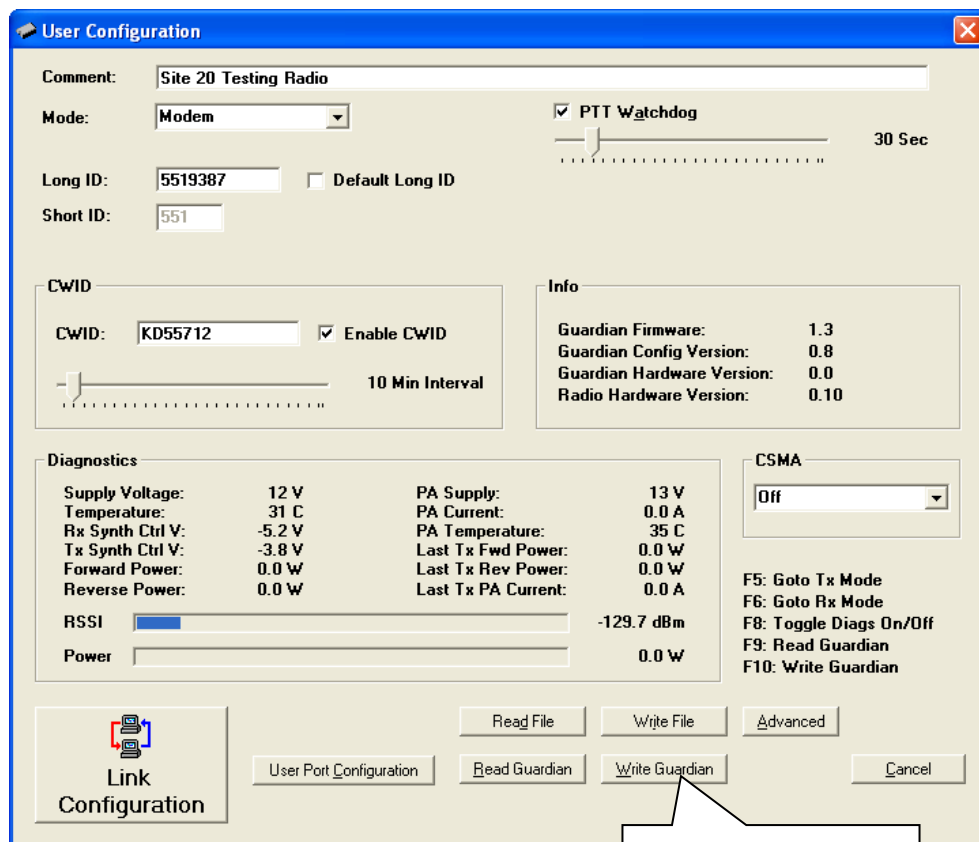

Programming of the Guardian is extremely fast. The message “Guardian Configuration Write Complete” appears. Click **OK**.

Figure 66 Guardian Configuration Write Complete



The Guardian has now been configured and is ready for installation.

INSTALLATION

As noted earlier, the Guardian footprint is different than the T-96SR.

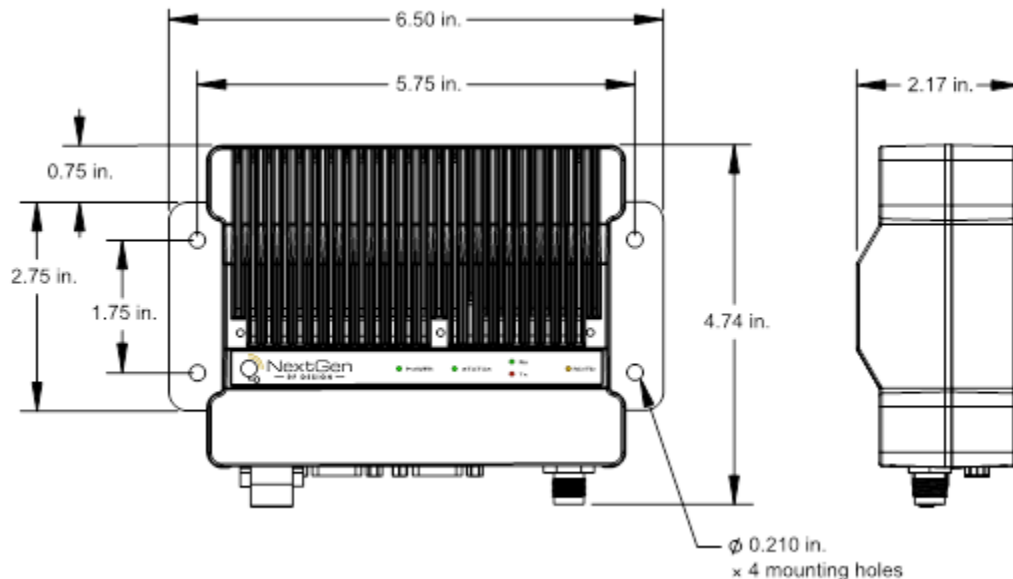

Figure 5 shows the mechanical dimensions for the Guardian. When mounting the Guardian, orientation should allow unrestricted airflow from the heat sink fins. If location, heat dissipation, or duty cycle are a concern, the addition of the Guardian Fan Kit may be considered. See Table 9 for a list of fan kits that are available for use with the Guardian.

Contact your sales representative for further information.

Antenna connection is a TNC Female 50-ohm connector. See Table 10 for available Coaxial Adapter Cables from NextGen RF.

Serial connection is a DE-9 female. This is a DCE connection. The RTU/PLC control equipment may be DTE or DCE equipment. If the RS-232 serial connection is DTE, a “straight through” serial cable should be used. If the equipment has a DCE connection, a “null modem” serial cable will be required.

For RTS/CTS handshaking flow control, five wires will be required for operation. These are as follows. (See Figure 3 and Table 4, earlier in this User Manual.)

- Pin 2 Receive Data – Data received by radio and output to a RTU/PLC.
- Pin 3 Transmit Data — Data sent to modem to be transmitted by the radio.
- Pin 5 Signal Ground – RS-232 ground and radio/modem chassis ground potential.
- Pin 7 Request to Send – RTS raised to RS-232 “High” to start transmitting mode and prepare modem to receive data.
- Pin 8 Clear to Send – CTS return RS-232 “High” to RTU/PLC 30 mSec after RTS is raised. Modem is ready to receive data.

DOX mode operation does not require RTS/CTS handshake control. When data is received on Pin 3 (TXD), data is buffered, and the radio is set to transmit mode. Data is transmitted when the radio/modem is ready to send it.

DOX mode requires 3 wire connections for operation. These are as follows. (See Figure 3 and Table 4, earlier in this User Manual.)

- Pin 2 Receive Data – Data received by radio and output to a RTU/PLC.
- Pin 3 Transmit Data — Data sent to modem to be transmitted by the radio.
- Pin 5 Signal Ground – RS-232 ground and radio/modem chassis ground potential.

For technical assistance, contact NextGen RF Wireless Network Group Technical Service at support@NextGenRF.com.

Product Warranty, RMA, and Contact Information

NextGen RF guarantees that every Guardian radio modem will be free from physical defects in material and workmanship for one (1) year from the date of purchase when used within the limits set forth in the specifications section of this manual.

The manufacturer's [warranty information](#) is available on the following page. If the product proves defective during the warranty period, contact NextGen RF Customer Service to obtain a Return Material Authorization (RMA). You may also request an RMA by contacting support@nextgenrf.com.

RMA Request/Contact Customer Service

NextGen RF Design
2130 Howard Drive W
North Mankato, MN 56003
Tel: 507-514-6245

BE SURE TO HAVE THE EQUIPMENT MODEL AND SERIAL NUMBER AND BILLING AND SHIPPING ADDRESSES ON HAND WHEN CALLING.

When returning a product, mark the RMA clearly on the outside of the package. Include a complete description of the problem and the name and telephone number of a contact person. RETURN REQUESTS WILL NOT BE PROCESSED WITHOUT THIS INFORMATION.

For units in warranty, customers are responsible for shipping charges to NextGen RF. For units returned out of warranty, customers are responsible for all shipping charges. Return shipping instructions are the responsibility of the customer.

Product Documentation

NextGen RF reserves the right to update its products, software, or documentation without obligation to notify any individual or entity. Product updates may result in differences between the information provided in this manual and the product shipped. For the most current product documentation and application notes, visit www.NextGenRF.com.

Tech Support

NextGen RF Design
2130 Howard Drive W
North Mankato, MN 56003
Tel: 507-514-6245
E-mail: support@nextgenrf.com

WARRANTY STATEMENT

NextGen RF warrants to the original purchaser for use ("Buyer") that data telemetry products manufactured by NextGen RF ("Products") are free from defects in material and workmanship and will conform to published technical specifications for a period of, except as noted below, one (1) year from the date of shipment to Buyer. NextGen RF makes no warranty with respect to any equipment not manufactured by NextGen RF, and any such equipment shall carry the original equipment manufacturer's warranty only. NextGen RF further makes no warranty as to and specifically disclaims liability for, availability, range, coverage, grade of service or operation of the repeater system provided by the carrier or repeater operator. Any return shipping charges for third party equipment to their respective repair facilities are chargeable and will be passed on to the Buyer.

If any Product fails to meet the warranty set forth above during the applicable warranty period and is returned to a location designated by NextGen RF. NextGen RF, at its option, shall either repair or replace such defective Product, directly or through an authorized service agent, within thirty (30) days of receipt of same. No Products may be returned without prior authorization from NextGen RF. Any repaired or replaced Products shall be warranted for the remainder of the original warranty period. Buyer shall pay all shipping charges, handling charges, fees and duties for returning defective Products to NextGen RF or authorized service agent. NextGen RF will pay the return shipping charges if the Product is repaired or replaced under warranty, exclusive of fees and duties. Repair or replacement of defective Products as set forth in this paragraph fulfills all warranty obligations on the part of NextGen RF.

This warranty is void and NextGen RF shall not be obligated to replace or repair any Products if (i) the Product has been used in other than its normal and customary manner; (ii) the Product has been subject to misuse, accident, neglect or damage or has been used other than with NextGen RF approved accessories and equipment; (iii) unauthorized alteration or repairs have been made or unapproved parts have been used in or with the Product; or (iv) Buyer failed to notify NextGen RF or authorized service agent of the defect during the applicable warranty period. NextGen RF is the final arbiter of such claims.

THE AFORESAID WARRANTIES ARE IN LIEU OF ALL OTHER WARRANTIES, EXPRESSED AND IMPLIED, INCLUDING BUT NOT LIMITED TO, ANY IMPLIED WARRANTY OF MERCHANTABILITY OR FITNESS FOR A PARTICULAR PURPOSE. NEXTGEN RF AND BUYER AGREE THAT BUYER'S EXCLUSIVE REMEDY FOR ANY BREACH OF ANY OF SAID WARRANTIES IS AS SET FORTH ABOVE. BUYER AGREES THAT IN NO EVENT SHALL NEXTGEN RF BE LIABLE FOR INCIDENTAL, CONSEQUENTIAL, SPECIAL, INDIRECT OR EXEMPLARY DAMAGES WHETHER ON THE BASIS OF NEGLIGENCE, STRICT LIABILITY OR OTHERWISE. The purpose of the exclusive remedies set forth above shall be to provide Buyer with repair or replacement of non-complying Products in the manner provided above. These exclusive remedies shall not be deemed to have failed of their essential purpose so long as NextGen RF is willing and able to repair or replace non-complying Products in the manner set forth above.

This warranty applies to all Products sold worldwide. Some states do not allow limitations on implied warranties so the above limitations may not be applicable. You may also have other rights, which vary from state to state.

EXCEPTIONS

THIRTY DAY: Tuning and adjustment of telemetry radios

NO WARRANTY: Fuses, lamps, and other expendable parts



ABOUT NEXTGEN RF

NextGen RF is a USA owned and operated engineering services company providing valuable wireless design expertise on a variety of products, ranging from design consultation to fully turnkey product development. Because we know design, NextGen RF has become the chosen partner for companies worldwide who require a high level of design expertise and responsiveness for their product development. We understand the difficulties of implementing RF solutions in designs and have a proven track record of helping clients efficiently meet their design objectives and requirements. We focus on process-oriented engineering from discovery and idea generation, definition of product requirements and specifications to design, verification and ultimately factory introduction. For more information visit www.nextgenrf.com